



In-line 2750

Submersible  
2750

2750-7

DryLoc® Electrodes sold separately.

The Signet 2750 pH/ORP Sensor Electronics featuring the DryLoc® connector, provides a variety of functions to suit various requirements.

The 2750 has a preamplified signal and features two different outputs: a two-wire 4 to 20 mA loop output with EasyCal function or a digital (S<sup>3</sup>L) output which allows for longer cable lengths and is compatible with the Signet 8900 or 9900 instruments.

The 2750 self-configures for pH or ORP operation via automatic recognition of the electrode type. The optional EasyCal feature allows simple push-button calibration and includes an LED indicator for visual feedback.

The DryLoc® electrode connector quickly forms a robust assembly for submersible and in-line installations. NEMA 4X junction enclosures are integral parts of the 2750 in-line version and are also available as accessories for the submersible 2750.

The 2750 submersible preamplifier can also be used as an In-line preamplifier when used with the 3/4" or 1" threaded sensors including the 2724, 2774 and 2764 series electrodes. The 2750 In-line preamplifier can be used with Signet fittings up to DN100 (4 in.) and wet-tap assemblies.

## Features

- In-line integral mount and submersible installation versions
- Automatic temperature compensation
- Auto configuration for pH or ORP operation
- Optional EasyCal calibration aid with automatic buffer recognition
- Junction boxes for convenient wiring
- Patented DryLoc® connector provides a quick and secure connection to the sensor\*



## Applications

- Water and Wastewater Treatment
- Neutralization Systems
- Scrubber Control
- Effluent Monitoring
- Surface Finishing
- Flocculent Coagulation
- Heavy Metal Removal and Recovery
- Toxics Destruction
- Sanitization Systems
- Pool & Spa Control
- Aquatic Animal Life Support Systems

\*U.S. Patent No.: 6,666,701



Tel: +44 (0) 1706 869777  
E-mail: [sales@desal.co.uk](mailto:sales@desal.co.uk)  
Web: [www.desal.co.uk](http://www.desal.co.uk)

# Specifications

## General

### Compatible Electrodes

Signet DryLoc® pH and ORP Electrodes, Models 2724-2726, 2756-2757 Wet-Tap, 2764-2767, 2774-2777

Operating Range	pH	0 to 14 pH
	ORP	±2,000 mV
Response Time	pH	< 6 sec. for 95% of change
	ORP	application dependent
Materials	In-line	Valox® (PBT)
	Submersible	CPVC

## Electrical

Cable	4.6 m	15 ft	3-conductor shielded (3-2750-3 or -4 submersible sensor electronics only)	
	22 AWG		For 9900 and 4 to 20 mA max. cable length is 1000 ft. (For 8900 please refer to the Cable Calculation Table on pg. 333 for max. cable length)	
Power	12 to 24 VDC		±10%, regulated for 4 to 20 mA output	
	5 to 6.5 VDC		±5% regulated recommended, 3 mA max., for digital (S <sup>3</sup> L) output	
Current Output	pH		Fixed 4 to 20 mA, isolated, = 0 to 14 pH (custom scaling available with 0250 tool)	
	ORP		Fixed 4 to 20 mA, isolated, = -1000 to 2000 mV (custom scaling available from ± 000 mV with 0250 tool)	
Max Loop Resistance	100 Ω max. @ 12 V	325 Ω max. @ 18 V	600 Ω max. @ 24 V	
Accuracy	±32 µA			
Resolution	±5 µA			
Update Rate	0.5 seconds			
Error Indication	3.6 mA			
Digital (S <sup>3</sup> L) Output	Serial ASCII, TTL level 9600 bps			
Accuracy	pH	± 0.03 pH @ 25 °C	± 0.03 pH @ 77 °F	
	ORP	± 2 mV @ 25 °C	± 2 mV @ 77 °F	
Resolution	pH	≤ 0.01 pH		
	ORP	1 mV		
Temperature	≤ 0.2 °C	0.36 °F		
Update Rate	0.5 seconds			
Available Data	Raw mV, pH or ORP, temperature (pH)			
Error Indication	Open input diagnostic			
Input Impedance, Z	>10 <sup>11</sup> Ω			

## Environmental

Enclosure	3-2750-1 & -2	NEMA 4X/IP65 with electrode connected
	3-2750-3 & -4	NEMA 6P/IP68 with electrode and watertight conduit and/or extension pipe connected

## Max. Temperature/Pressure Rating

### Operating Temperature

submersible	0 °C to 85 °C	32 °F to 185 °F
	0 °C to 110 °C	32 °F to 230 °F
Storage Temperature	-20 °C to 85 °C	-4 °F to 185 °F
Relative Humidity	0 to 95%, non-condensing (without electrode connected)	

## Shipping Weight

	2750-1 & 2	0.75 kg	1.65 lb
	2750-3 & -4	0.64 kg	1.41 lb

## Standards and Approvals

CE, FCC
RoHS compliant, China RoHS
Manufactured under ISO 9001 for Quality and ISO 14001 for Environmental Management and OHSAS 18001 for Occupational Health and Safety

# Dimensions

3-2750-1,-2

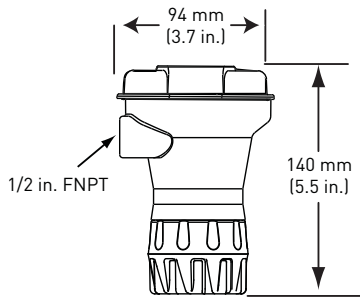

3-2750-3, -4

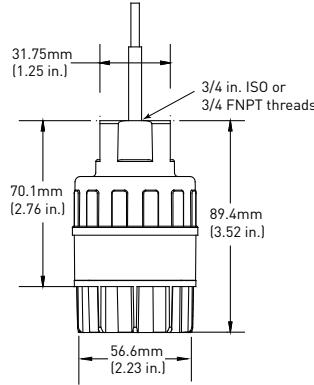

3-2750-7

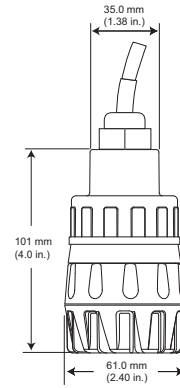

## In-Line Installation

System Overview

Panel Mount	4 to 20 mA input	
Signet Instruments 8900 9900 	Customer Supplied Chart Recorder or Programmable Logic Controller 	
<b>Signet 2750 Sensor Electronics</b> 	<b>Signet 2750 Sensor Electronics</b> with Signet 3-8050-2 Universal Junction Box (EasyCal) 	<b>Signet 2750 Sensor Electronics</b> 
Signet Electrodes 2724-2726 2764-2767 2774-2777 		
2724-2726 DryLoc® Electrodes: Use GF Fittings* or customer supplied 3/4 in. NPT fittings		All sold separately
2764-2767 and 2774-2777 DryLoc® Electrodes: Use customer supplied 3/4 in. or 1 in. NPT fittings		







## Submersible Installation

## Wet-Tap Installation

Panel Mount	4 to 20 mA Input	
Signet Instruments 8900 9900 	Customer Supplied Chart Recorder or Programmable Logic Controller 	
<b>Signet 2750 Sensor Electronics</b> with customer supplied pipe extension or conduit, 3/4 in. NPT or ISO 7/1-R 3/4 threads** 	<b>Signet 2750 Sensor Electronics</b> with Signet Wet-Tap Electrode 2756, 2757 and Signet 3719 Wet-Tap 	
Signet Electrodes 2724-2726 2764-2767 2774-2777 	GF Tees and Fittings see model 3719 for more info   All sold separately	

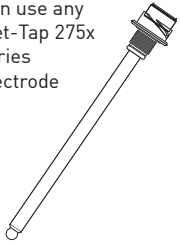
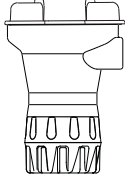
\* See fittings section for more information.

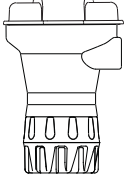
# 2750 Product Selection Guide

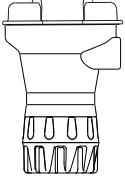
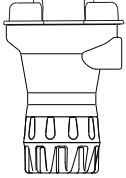
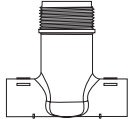
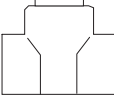
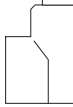
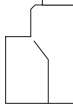
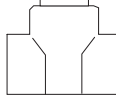
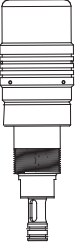
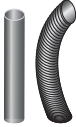
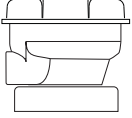
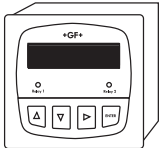
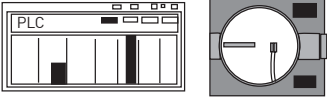
<p><b>1. Choose the Electrode</b></p>	<p>2724-2726</p> <p>Can use Any 3-272x series Electrode</p> 	<p>2764-2767 Differential</p> <p>3-2764-1 3-2764-2 3-2766-1 3-2766-2</p> 	<p>2774-2777</p> <p>ORP electrodes must have 10K ID resistor use: 3-2775, 3-2777</p> <p>pH Electrodes can be either the 1K or 3K use: 3-2774, 3-2774-1, 3-2776, 3-2776-1</p> 	<p>2756 and 2757 Wet-Tap</p> <p>Can use any Wet-Tap 275x series electrode</p> 		
<p><b>2. Determine the mounting style:</b></p>	<p>In-line</p>  <p>2750-1 or -2</p>	 <p>2750-3 or -4</p>	 <p>2750-1 or -2</p>	 <p>2750-3 or -4</p>	 <p>2750-1 or -2</p>	 <p>2750-1 or -2</p>
<p>And</p>	<p>-In-line fitting</p> 	<p>Signet fitting</p> 	<p>¾" reducing tee</p> 	<p>1" threaded tee</p> 	<p>¾" reducing tee</p> 	 <p>3719 Wet-Tap Assembly</p>
<p>Or</p>	<p>Submersible</p> <p>2750-3 or -4 and cable conduit (customer supplied) connected to ¾" sensor electronics</p> 					<p>(Submersible not applicable with Wet-Tap assembly)</p>
<p><b>3. Junction Boxes</b></p>	<p>3-8050-1: Use when extending the submersible cable over long distance. 3-8050-2: Use with the submersible 2750-3 or -4 and the in-line 2750-1 for best calibration results with the EasyCal function when using the blind 4 to 20 mA output.</p>					
<p><b>4. Choose the output instrument</b></p>	<p>Digital (S<sup>3</sup>L)</p> <p>Or</p> <p>4 to 20 mA</p>  <p>8900 or 9900 Instruments</p>	<p>OR</p>	 <p>PLCs or Chart Recorders</p>			

## Model 2750 Ordering Information

- 1) Model 2750 requires 12 to 24 VDC to function as a blind 4 to 20 mA output transmitter.
- 2) Order a 3-2750-2 or any other 2750 with a junction box 3-8050-2 if the EasyCal feature is desired.
- 3) Conduit and mounting brackets for submersion installation must always be used (customer supplied).
- 4) The 3-2759 System Tester must be ordered with the adapter cable 3-2759.391 for exclusive use with the 2750.
- 5) All sensor electronics, preamplifiers and connectors require a DryLoc® electrode for full system installation.

## Application Tips

- The EasyCal feature automatically recognizes standard 4.0, 7.0, and 10.0 pH buffer or ORP quinhydrone solutions of 87 and 264 mV and simplifies calibration
- Frequency of calibration of electrodes is dependent upon the application.

## Ordering Information

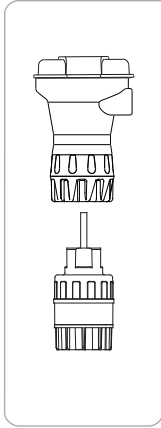

Mfr. Part No.	Code	Description
In-line Sensor Electronics (Yellow body)		
3-2750-1	<b>159 000 744</b>	Recommended for 8900 or 9900 instruments
3-2750-2	<b>159 000 745</b>	with EasyCal, recommended for 4 to 20 mA use
3-2750-7	<b>159 001 671</b>	pH electronics, Digital (S <sup>3</sup> L), 4.6 m (15 ft) cable
Submersible Sensor Electronics (Grey body)		
3-2750-3	<b>159 000 746</b>	with 4.6 m (15 ft) cable and 3/4 in. NPT threads - when 4 to 20 mA is required use the 3-8050-2 junction box with EasyCal
3-2750-4	<b>159 000 842</b>	Submersible Sensor electronics with 4.6 m (15 ft) cable and ISO 7/1R 3/4 threads - when 4 to 20 mA is required use the 3-8050-2 junction box with EasyCal

Sensor Electronics with preamplified signal and Digital (S<sup>3</sup>L) output (for use with the Multi-Parameter Instruments) or 4 to 20 mA output - power supplied to unit dictates output type.

## Accessories and Replacement Parts

Mfr. Part No.	Code	Description
<b>Calibration</b>		
3-2700.395	<b>159 001 605</b>	Calibration kit: includes 3 polypropylene cups, box used as cup stand, 1 pint pH 4.01, 1 pint pH 7.00
3822-7115	<b>159 001 606</b>	20 gm bottle quinhydrone for ORP calibration (must use pH 4.01 and/or pH 7.00 buffer solutions)
3-2759	<b>159 000 762</b>	pH/ORP system tester (adapter cable sold separately)
3-2759.391	<b>159 000 764</b>	2759 adapter cable for use with 2750 -DryLoc <sup>®</sup> sensor electronics
3-0700.390	<b>198 864 403</b>	pH buffer kit (1 each 4, 7, 10 pH buffer in powder form, makes 50 ml of each)
3822-7004	<b>159 001 581</b>	pH 4 buffer solution, 1 pint (473 ml) bottle
3822-7007	<b>159 001 582</b>	pH 7 buffer solution, 1 pint (473 ml) bottle
3822-7010	<b>159 001 583</b>	pH 10 buffer solution, 1 pint (473 ml) bottle
<b>Mounting</b>		
3-8050.390-1	<b>159 001 702</b>	Retaining nut replacement kit, Valox K4530
3-8050-1	<b>159 000 753</b>	Universal mount junction box
3-8050-2	<b>159 000 754</b>	Universal mount junction box w/EasyCal (for submersible applications, use with 3-2750-3/4 where 4 to 20 mA is required)
3-9000.392-1	<b>159 000 839</b>	Liquid tight connector kit, NPT (1 connector)
3-9000.392-2	<b>159 000 841</b>	Liquid tight connector kit, PG 13.5 (1 connector)
<b>Other</b>		
5523-0322	<b>159 000 761</b>	Sensor cable (per ft), 3-cond. plus shield, 22 AWG, black/red/white (for use with 2750)

### 3-2750.099 Rev F (6/13)

© Georg Fischer Signet LLC

3401 Aero Jet Avenue, El Monte, CA 91731-2882 U.S.A. • Tel. (626) 571-2770 • Fax (626) 573-2057 • www.gfsignet.com • e-mail: signet.ps@georgfischer.com  
 Specifications subject to change without notice. All rights reserved. All corporate names and trademarks stated herein are the property of their respective companies.