

Signet 9900 Transmitter



3-9900.090 Rev 9 07/20

Operating Instructions



Panel Mount



Field Mount



- [English](#)
- [Deutsch](#)
- [Français](#)
- [Español](#)
- [Italiano](#)
- [中文](#)



Quick Start



Look for the Quick Start icon to quickly set up your new 9900.

Your new Signet 9900 Transmitter needs to be calibrated and the sensor needs to be initialized prior to use. The following steps outline the recommended procedure to start up a new system.

1. **Module Installation (page 3)**
2. **Installation (page 7)**
3. **Wiring (page 8)**
4. **Sensor Wiring (page 11)**
5. **Power Wiring (page 16)**
6. **Relay and Open Collector Wiring (page 17)**
7. **Relay Functions (page 18)**
8. **Operation (page 22)**
9. **Menu System (page 24)**

Description

The 9900 Transmitter, a member of Signet's line of SmartPro® instruments, provides a single-channel interface for all Flow, pH/ORP, Conductivity/Resistivity, Salinity, Pressure, Temperature, Level, Dissolved Oxygen, Batch and other applications.

The 9900 is available in either Panel or Field Mount. Both versions run on 10.8 to 35.2 VDC power (24 VDC nominal), and can power certain sensors on loop power (see NOTE on page 11).

The 9900 Transmitter, also allows third-party 4 to 20 mA signals to be used as an input (optional Signet 8058 i-Go® Signal Converter required, sold separately).

Compatibility

The 9900 is compatible with all GF Signet products listed in the column to the right.

- pH and ORP electrodes require the Signet 2751 DryLoc® Sensor Electronics (sold separately).
- Conductivity/Resistivity or Salinity measurement requires either the optional Direct Conductivity/Resistivity Module (part number 3-9900.394) or the Signet 2850 Conductivity/Resistivity Sensor Electronics (sold separately).

NOTE: If using the 2850, use the one-channel Digital (S³L) models. The two-channel model 3-2850-63 may be used with only one channel connected. Do not use with both channels connected. The 4 to 20 mA models 3-2850-52 and 3-2850-62 are incompatible with the 9900.

Flow 515*/8510*, 525*, 2000, 2100, 2507, 2536*/8512*, 2537, 2540*, 2551, 2552, 258X
pH/ORP 2724-2726 with 2751 2734-2736 with 2751 2756-WTx-2757-WTx with 3719 and 2751 2764-2767 with 2751 2774-2777 with 2751
Conductivity/Resistivity, Salinity 2819-2823 with 2850 or Cond/Res Module 2839-2842 with 2850 or Cond/Res Module
Level, Temperature, Pressure 2250*, 2350*, 2450*
Dissolved Oxygen 2610-51 direct to 9900
* Can be run on Loop Power (see NOTE on page 11)

Warranty Information

Refer to your local Georg Fischer Sales office for the most current warranty statement.

All warranty and non-warranty repairs being returned must include a fully completed Service Form and goods must be returned to your local GF Sales office or distributor.

Product returned without a Service Form may not be warranty replaced or repaired.

Signet products with limited shelf-life (e.g. pH, ORP, chlorine electrodes, calibration solutions; e.g. pH buffers, turbidity standards or other solutions) are warranted out of box but not warranted against any damage, due to process or application failures (e.g. high temperature, chemical poisoning, dry-out) or mishandling (e.g. broken glass, damaged membrane, freezing and/or extreme temperatures).

Product Registration

Thank you for purchasing the Signet line of Georg Fischer measurement products.

If you would like to register your product(s), you can now register online in one of the following ways:

- Visit our website www.gfsignet.com. Under **Service and Support** click **Product Registration Form**
- If this is a pdf manual (digital copy), [click here](#)

Safety Information

- Follow instructions carefully to avoid personal injury.
- This unit is designed to be connected to equipment which can be hazardous to persons and property if used incorrectly.
- Read and understand all associated equipment manuals and safety warnings before using with this product.
- Remove power to unit before wiring connections.
- Wiring connections to this product should only be performed by qualified personnel.
- Do not use unit if front panel is cracked or broken.





	Caution / Warning / Danger Indicates a potential hazard. Failure to follow all warnings may lead to equipment damage, injury, or death
	Electrocution Danger Alerts user to risk of potential of injury or death via electrocution.
	Electrostatic Discharge (ESD) Alerts user to risk of potential damage to product by ESD
	Personal Protective Equipment (PPE) Always utilize the most appropriate PPE during installation and service of Signet products.
	Note / Technical Notes Highlights additional information or detailed procedure.

Table of Contents

General Information	2
Dimensions	3
Module Installation	3
Plug-In Modules	4
Relay Module	4
Direct Conductivity/Resistivity Module	5
H COMM or Modbus Module	5
Batch Module	6
4 to 20 mA Output Module	6
Installation	7
Wiring	8
Signal Type: Frequency	9
Signal Type: Digital (S ³ L)	9
Signal Type: 4 to 20 mA	10
Terminal Identification	10
Sensor Wiring	11
Power Wiring	16
Relay and Open Collector Wiring	17
Relay Functions	18
Relay and Open Collector Outputs	18
Operation	22
Menu System	24
System Setup Menu	24
Common Menus	26
LOOP Menu	26
RELAY Menu	27
OPTION Menu	29
Modbus	30
Sensor-Specific Menus	31
Flow	31
pH	33
ORP	35
Conductivity/Resistivity	37
Pressure	39
Level/Volume	40
Temperature	42
4 to 20 mA	43
Salinity	45
Dissolved Oxygen	47
Troubleshooting	49
Appendix	51
Averaging	51
LOG Current Loop Output	51
Custom Measurements	52
Calibration Procedures - pH	56
Calibration Procedure - ORP	58
Calibration Procedure - Conductivity/Resistivity	60
Calibration Procedure - Flow	61
Calibration Error Messages	62
USP Limits	63
H COMM Module Overview	64
H COMM Module Installation	65
H COMM Module Wiring	65
H COMM Module Operation	67
HART Commands	68
Unit Codes	69
Specifications	70
Maintenance	71
Ordering Information	72

Dimensions

Panel Mount 3-9900-1P

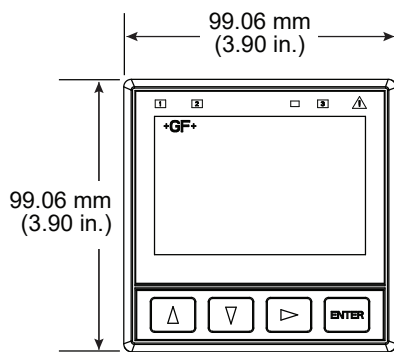

29.97 mm
(1.18 in.)

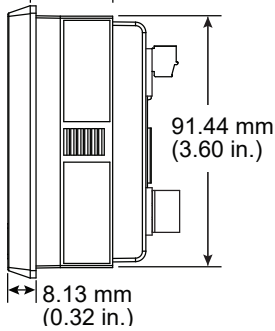

Side View

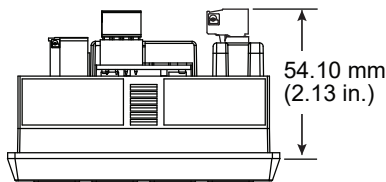

Top View

Field Mount 3-9900-1

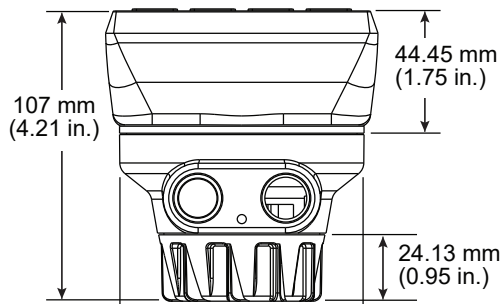

(3-8051-X shown)

NOTE: 3-8051-X Integral Mounting Kit sold separately.

3-9900.396 Angle Adjustment Adapter Kit

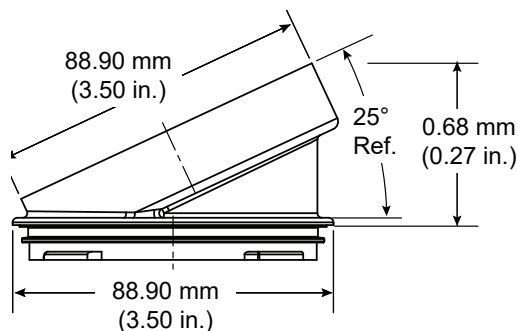

Module Installation

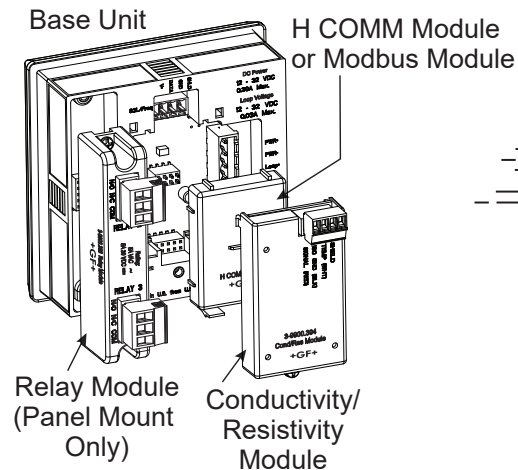

If the 9900 Base Unit will be mounted in a panel, the plug-in modules may be installed either before or after the base unit is mounted. If the 9900 Base Unit will be mounted using the wall mount accessory kit (3-9900.392), install plug-in modules first.

If installing both the Conductivity/Resistivity (Cond/Res) and either the H COMM or Modbus Modules, install the H COMM/Modbus Module first, then the Cond/Res Module on top of it. (see illustration on page 5).



CAUTION

Exercise care when installing modules. Do not bend connecting pins.

To install modules:

Remove power from the 9900. Carefully align pins and connectors (do not bend connecting pins) and push module firmly into place, then attach with screw(s) (except H COMM Module).



CAUTION

LOOP as well as DC power MUST be removed BEFORE installing or removing ANY Module.

To remove modules:

Remove power from the 9900.

For Relay, Cond/Res, and 4 to 20 mA Output Modules, unplug connectors, remove screw(s), and carefully pull module straight out from the base unit. Do not bend the connecting pins.

For H COMM or Modbus Module, squeeze the tabs on the bottom edge, grasp the module and pull straight out. Do not bend the connecting pins.

For Batch Module, remove the Relay module. Loosen bottom screw of Batch module. Carefully grip and squeeze the tabs at the top of the module to release. Pull module away from the unit. Do not bend the connecting pins.



WARNING

Relays may be connected to external high-voltage power sources or multiple power sources creating an electrocution hazard.

Plug-In Modules

Optional modules and accessories are available for the 9900:

- Base Unit (required)
- Slot for optional H COMM or Modbus Module
- Slot for optional Conductivity/Resistivity, Batch, or 4 to 20 mA Output Module
- Slot for optional Relay Module (not available on field mount)

Each item is ordered separately.

Modules are field-replaceable at any time.

See Module Installation (pg. 3) and Ordering Information (pg. 72) sections for more details.

9900 Module	9900 Generation				
	I	II	III	IV	V
H COMM*	X	X	X	X	X
Modbus	X	X	X	X	X
Relay	X	X	X	X	X
Conductivity/ Resistivity	X	X	X	X	X
Batch		X	X	X	X
4-20mA Output*			X	X	X

*Able to run on Loop power



CAUTION

Avoid Electrostatic Discharge (ESD).

- Minimize handling of the plug-in modules to reduce the possibility of damage due to ESD.
- Handle modules by the edges. Never touch any exposed circuitry or contacts.
- Wear an anti-static wristband or stand on an anti-static mat, or keep one hand touching a properly grounded pipe or other piece of properly grounded metal when handling modules.

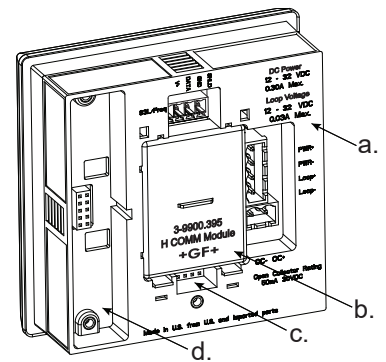

Relay Module

(Panel Mount installations only)

Mfr. Part No.	Code	Description
3-9900.393	159 001 698	Relay Module - Two dry-contact relays

In addition to the standard programmable Open Collector output in the base unit, the Panel Mount version of the 9900 has a slot for an optional Relay Module, which adds two programmable dry-contact relays. The Open Collector output in the base unit uses the Relay 1 setting in the menus. If the optional Relay Module is installed, these are assigned to relays 2 and 3 in the menus.

Dry-contact relays are electromechanical switches with a moving contact armature. They are suitable for many general-purpose applications, AC or DC, including AC loads up to 250 V. Install RC Filter Kits, 3-8050.396, on relays used to switch motor or inductive loads.

- Two (2) SPDT dry-contact relay (DCR) inputs
- User programmable
- 250 V, 5 A maximum resistive loading (AC)
- Can switch line voltage (typically 120 to 240 VAC)
- Can switch DC voltage (< 30 VDC @ 5A)
- Larger voltage and current ratings than Open Collector outputs

For wiring information, refer to the Relay and Open Collector Wiring section, page 17.

NOTE:

The Relay Module requires 10.8-35.2 VDC, 300 mA power connection to DC PWR Terminals. The Relay Module cannot be used with loop power.

- The two red Mechanical Relay Indicator LEDs on the front panel of the 9900 show the status of relays 2 and 3. (Status of all relays and Open Collector is available at all times in a single screen in View mode.)
- Hysteresis and time delay are adjustable for each relay.

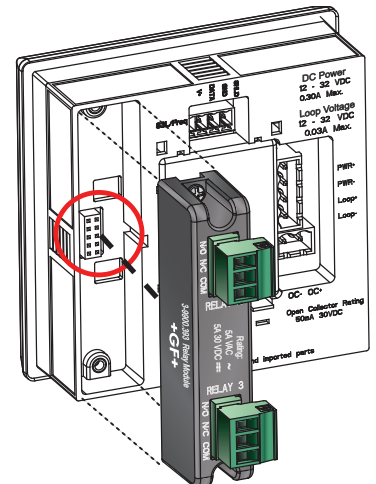

CAUTION

DO NOT bundle Relay Module wiring with other wiring.

Doing so may cause injury and/or damage to 9900 Transmitter, Relay Module, and Batch Module.

CAUTION

Switching active loads (usually inductive) can cause contact arcing sufficient to damage the relays.



The RC Filter Kit or "snubber" (part number 3-8050.396) is available as an accessory to reduce or eliminate these damaging effects. Recommended for inductive loads greater than 50 VAC (remote relays, solenoids, pumps, etc.)

Direct Conductivity/Resistivity Module

Mfr. Part No.	Code	Description
3-9900.394	159 001 699	Direct Conductivity/Resistivity Module

The Direct Conductivity/Resistivity (Cond/Res) Module interfaces Signet 2818-2823 and 2839-2842 Conductivity electrodes directly to the 9900. (Conductivity/Resistivity and Salinity measurements may also be performed via the 2850 Sensor Electronics connected through the 9900 Digital (S³L) input.)

- Provides filtering and conditioning.
- Sensor cable length can be extended to 30 m (100 ft).
- 2839 - 2842 sensors come with a cell constant certificate to improve the accuracy of the sensor measurements (see page 37).

Signet Conductivity Module cannot operate when using loop power and requires an external DC power supply to be used with the 9900 Transmitter (see Power Wiring, pg. 16).

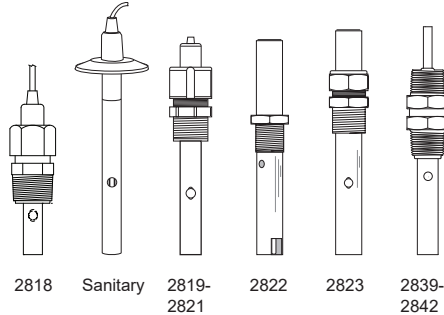

H COMM Module

Mfr. Part No.	Code	Description
3-9900.395	159 001 697	H COMM Module

The H COMM Module enables communication between the 9900 and a HART®-enabled device. The HART (Highway Addressable Remote Transducer) Protocol superimposes digital signals on top of the 4 to 20 mA analog signal.

Refer to the 9900 H COMM Module Instruction Sheet 3-9900.094 for further details.

NOTE:

With H COMM Module installed, a minimum of 24 V is required for loop-powered systems.

See Appendix for H COMM Module Overview, Installation, Wiring, Operation, HART Commands, and Unit Code information. (See page 64-69)

Modbus Module

Mfr Part No.	Code	Description
3-9900.270-M2	159 200 121	Modbus Module with Terminal Block Assembly (Panel Mount Only)
3-9900.270-M3	159 200 122	Modbus Module with M12 Connector Assembly (Field Mount Only)
3-9900.270-M4	159 200 128	Modbus Module with Wire Cable Assembly

The Signet 9900 Modbus Module allows the Signet 9900 SmartPro® Transmitter to connect to a Modbus master compatible device. The Modbus Module supports RTU or ASCII modes over serial RS485 communication links.

Refer to the Modbus Module Instruction Sheet, 3-9900.270.091, and Programming Manual, 3-9900.270.090 for installation and operation instructions.

Refer to the 9900 H COMM Module Instruction Sheet 3-9900.094 for further details.

NOTE:

The Modbus Module is not compatible with Loop Power, an external DC power supply is required.

HART® is a registered trademark of the HART Communication Foundation, Austin, Texas, USA. Any use of the term HART hereafter in this document implies the registered trademark.

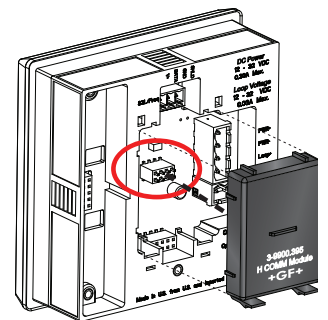
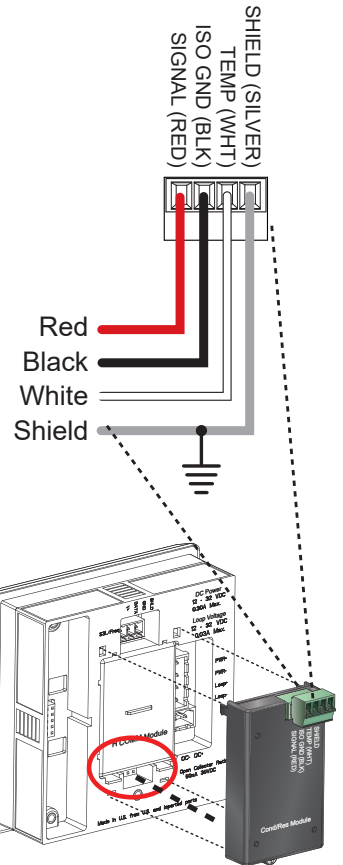

NOTE:
The H COMM Module can run on Loop Power.

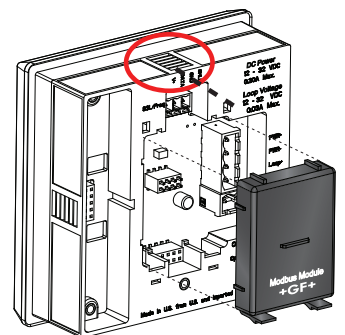

Batch Module

Mfr. Part No.	Code	Description
3-9900.397	159 310 163	Batch Module

Convert a 9900-1P Transmitter (Generation II** or later) into a Batch Controller system by utilizing a Batch Module (3-9900.397) and a Relay Module (3-9900.393).

Optional Module Wiring:

- Wire an external button or keypad (customer supplied) to stop, start or resume a batch remotely.
- *Wire an external input that can inhibit a batch from starting.

Full 9900-1BC Batch Controller System manual available at www.gfsignet.com

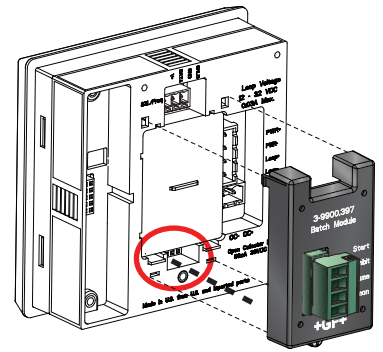
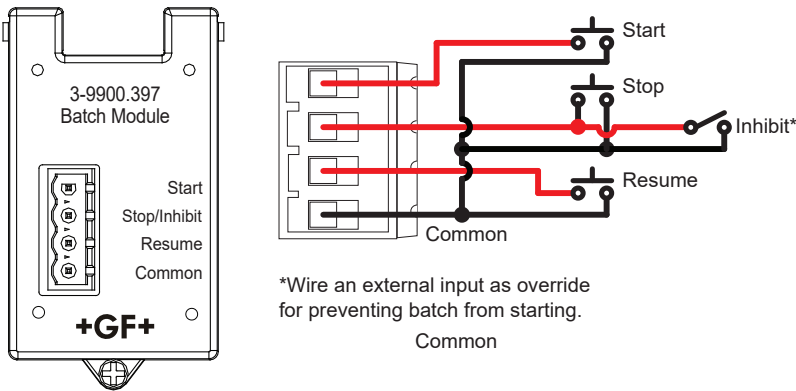

****NOTE:**
Verify 9900 Transmitter generation in the OPTIONS Menu.

4 to 20 mA Output Module

Mfr. Part No.	Code	Description
3-9900.398-1	159 001 784	4 to 20 mA Output Module

The optional 4 to 20 mA Output Module adds an additional 4 to 20 mA loop output to a Signet 9900 Transmitter (Panel or Field Mount). Requires the 9900 Generation III** or later.

Features:

- 4 to 20 mA Output Module can be powered using Loop Power or DC Power in the 9900 base unit.
- Independent settings for the loop currents of the Output Module and 9900 base unit. (Error, Loop Adjustments, etc.)
- The Primary or Secondary (if applicable) measurement of a compatible sensor can be selected as the loop source.
- The same source (Primary or Secondary measurement) can be used for Loop 1 in the 9900 base unit and Loop 2 in the Output Module.

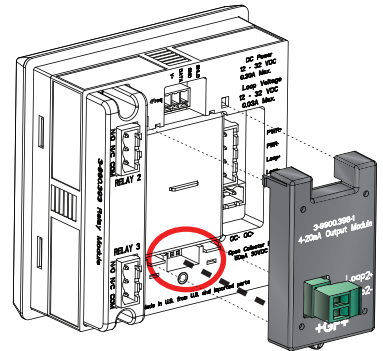
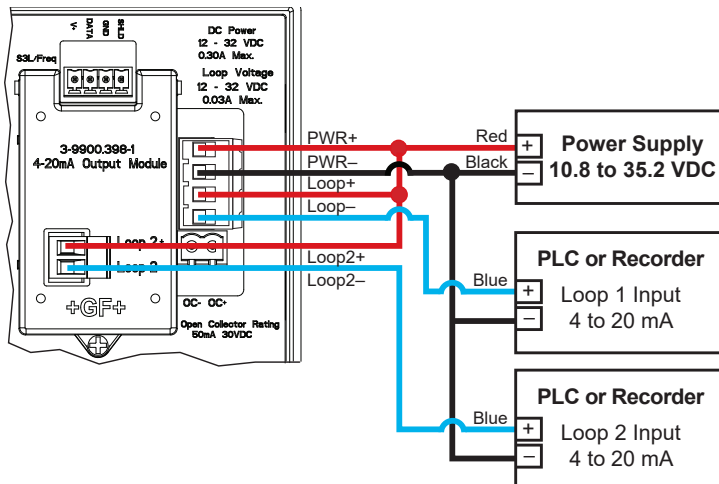

NOTE:
The 4 to 20 mA Output, Direct Conductivity, and Batch Modules share the same installation site on the 9900 base units.

Only one of these modules can be used per 9900 Transmitter.

NOTE:
The Output Module can run on Loop Power.

Installation

System Start-up: Step 1

Prepare the transmitter installation location. If the back of the transmitter is difficult to access when installed, wire the removable terminal blocks first, then install it completely.

Next step: Wiring (see page 8)

For future reference, for each installation, it is recommended to record the part number and serial number of each of the components listed here:

Facility Tag Number or System ID (user assigned): _____

Base unit 3-9900-____ S/N _____

Relay Module 3-9900.393 S/N _____

Cond/Res Module 3-9900.394 S/N _____

H COMM Module 3-9900.395 S/N _____

Modbus Module 3-9900.270-M__ S/N _____

Batch Module 3-9900.397 S/N _____

4 to 20 mA Output Module 3-9900.398-1 S/N _____



Do not mount in direct sunlight.

Panel Mount Installation

Tools and Equipment Required

- Fine-tooth file
- ¼ DIN punch or jigsaw suitable for cutting panel opening to within 1 mm (0.04 in) tolerance.
- ¼ DIN punches are available and recommended for creating clean, precise openings quickly and easily in most instrument panels.
- If a punch is not available, a jigsaw or other cutting tool can be used. An adhesive template is provided to help guide the cutting process. De-burr and smooth the opening with a file.

1. The panel mount transmitter is designed for installation using a ¼ DIN punch. Recommended clearance on all sides between instruments is 25 mm (1 in).
2. Place gasket on instrument, and install in panel.
3. Slide mounting bracket over back of instrument until bracket snaps into latches on sides of instrument.

To remove:

1. Secure instrument temporarily with tape from front or grip from rear of instrument. **DO NOT RELEASE.**
2. Press bracket clips outward and remove.

Field Mount Installation

Field mounting requires a separate mounting kit. The 3-8050 Universal Mount Kit, the 3-8051 or 3-8052 Integral Mount Kits, and the 3-9900.396 Angle Adjustment Adapter Kit enable the transmitter to be installed virtually anywhere. Detailed instructions for field installation options are included with the 3-8050, 3-8051 and 3-8052 adapter kits (see Ordering Information section).

For Field Mount installations with a Cond/Res Module, the 3-9900.396 Angle Adjustment Adapter is required along with a 3-8050 or 3-8052 adapter kit to allow for sufficient clearance for the wiring.

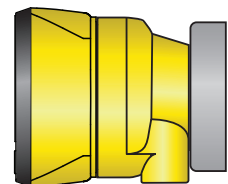
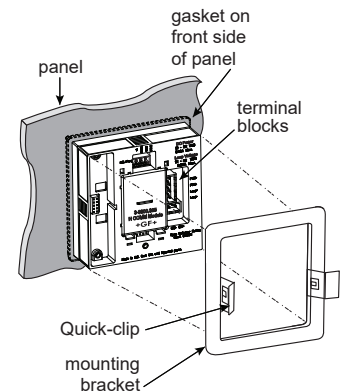
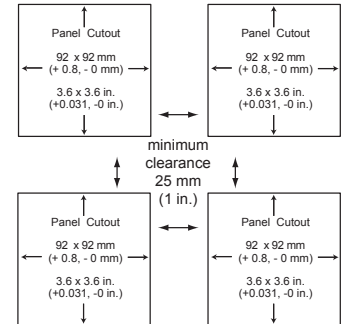

Field Mount with
3-8050 Universal Mount Kit

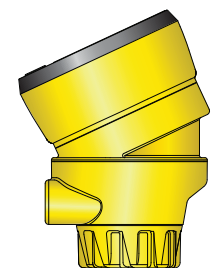

Field Mount with
3-8051 Integral Mount Kit
and Angle Adjustment Adapter

System Start-up: Step 2

Wire the transmitter for all connections with the power off. Keep any 4 to 20 mA and relay-actuated output devices that are connected to it offline at this time. Connect the sensors (page 11), power (page 16) and relay(s) (page 17).

Next step: Relay Functions (see page 18)

Wiring Tips:

- Do not route the sensor, DC power, or 4 to 20 mA cables in conduit containing AC power wiring. Electrical noise may interfere with sensor signal.
- Routing the sensor cable in grounded metal conduit can help prevent electrical noise and mechanical damage.
- Seal the cable entry points to prevent moisture damage.
- Only one wire should be inserted into a terminal.
- Splice double wires outside the terminal or use appropriate wire ferrule, not to exceed 2 mm (0.08 in) diameter.

All wiring connections to the 9900 are made via removable terminals.

In general:

- The Power, Loop and Open Collector plugs and the Relay Module plug accept 12 to 28 AWG wire.
The S³L/Freq plug and the Cond/Res Module plug accept 16 to 28 AWG wire.
- Strip 7 mm (0.28 in.) of insulation from wire tips and tin bare ends to eliminate fraying.
- Insert wire tip or ferrule completely into the terminal and secure with the screw.
- Do not allow any AC leads that may be connected to the internal relays to come in contact with low voltage wiring.



CAUTION:
Avoid Electrostatic Discharge (ESD)

- Minimize handling of plug-in modules to reduce the possibility of damage due to ESD.
- Handle modules by the edges. Never touch any exposed circuitry or contacts.
- Wear an anti-static wristband or stand on an anti-static mat, or keep one hand touching a properly grounded pipe or other properly grounded piece of metal when handling modules.



Tools Required

- Phillips screwdriver
- Flat-head screwdriver
- Wire strippers



For Field Mount installations, refer to the wiring diagram inside the Field Mount housing.

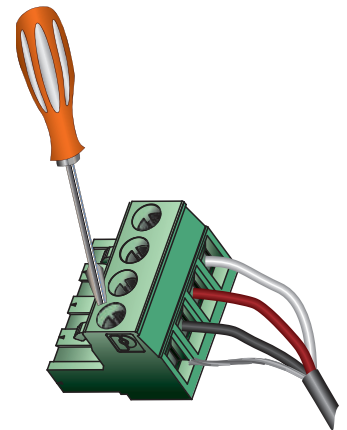

Signal Type: Frequency

Signet flow sensors 515/8510, 525, 2000, 2100, 2507, 2536/8512 and 2540 provide a frequency output. (Flow sensors 2551, 2552, and 258X can be configured with either Digital (S³L) or Frequency outputs, see page 13)

The maximum allowable cable length for sensors with frequency output is dependent upon the output signal strength of the sensors themselves, and the degree to which the signals are susceptible to EMI or "noise." This is largely a function of whether the sensors are self-powered (515/8510 and 525), or powered by an external source.

- The input terminals on the 9900 carry frequency data signals from the sensor.
- Do not route sensor or output cables in conduit containing AC power wiring. Electrical noise may interfere with sensor signal.
- Routing cable in grounded metal conduit will help prevent electrical noise and mechanical damage.
- Seal cable entry points to prevent moisture damage.
- Only one wire should be inserted into a terminal. Splice double wires outside the terminal.
- In case of noise interference, ground the sensor SHIELD wire to a local earth ground at a point near the sensor.
- Consult the sensor manual for additional wiring information.

Signal Type: Digital (S³L)

- The input terminals on the 9900 carry Digital (S³L) serial data from the sensor.
- Do not route sensor or output cables in conduit containing AC power wiring. Electrical noise may interfere with sensor signal.
- Routing cable in grounded metal conduit will help prevent electrical noise and mechanical damage.
- Seal cable entry points to prevent moisture damage.
- Only one wire should be inserted into a terminal. Splice double wires outside the terminal.
- The TOTAL cable length from I/O devices to the transmitter must not exceed 305 m (1000 ft).
- In case of noise interference, ground the sensor SHIELD wire to a local earth ground at a point near the sensor.
- Consult the sensor manual for additional wiring information.
- The maximum cable length of the Digital (S³L) bus varies depending on the types of sensors connected and the size of the conductors in the cable. For best results, determine the maximum cable length for the system before routing cables.
- There are several methods that can help route the digital cables and remain within the distance limitations.

Flow sensor models with Frequency Output	Maximum Cable Length	
	60 m (200 ft)	305 m (1000 ft)
515/8510	X	
525	X	
2000		X
2100		X
2507		X
2536/8512		X
2537		X
2540		X
2551		X
2552		X
258X		X



In case of noise interference, connect the cable shield to earth ground.

Maximum total cable length of the Digital (S³L) Bus:

The quality of the cable used in the bus determines the maximum length of all branches combined. The maximum cable length may not exceed 305 m (1000 ft), regardless of current requirements.

Signal Type: 4 to 20 mA

When connecting a non-Signet sensor to the 9900, the sensor's 4 to 20 mA signal must be converted to Digital (S³L). The 8058 i-Go Signal Converter accepts any 4 to 20 mA signal and converts it into Digital (S³L).

1. Wire the 8058 between the 4 to 20 mA loop source and the 9900 Digital (S³L) input terminals (see page 14).
2. In the 9900 INPUT TYPE menu (see System Setup Menu discussion, page 24), specify 4 to 20 mA INPUT.
3. Set additional labels and abbreviations as described on pages 43-44.

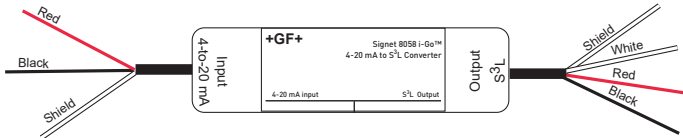

8058-1

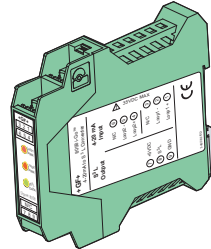

8058-2



For the 8058-2, connect Channel 1 ONLY

Terminal Identification



The 9900 requires regulated **10.8 to 35.2 VDC (24 VDC nominal)** from an external power supply (not supplied).

Maximum current draw is:

200 mA = 9900 without Relay module

300 mA = 9900 with Relay module

- **Terminals 1-2: DC Power**
Required by the instrument
 - 10.8 to 35.2 VDC input power to sensors, relays and the LCD backlight
- **Terminals 3-4: Loop Power (may also be used for system power)**
 - 10.8 to 35.2 VDC
 - NOTE:** Backlight, LEDs, Modbus and optional Relay Module do not operate on loop power. Any connected sensors or sensor electronics that cannot operate on loop power will also be inoperative.
- **Terminals 5-6: Open Collector**
 - Software selectable for Normally Open or Normally Closed.
 - May be disabled (Off) if not used.
- **Terminals 7-10: Digital (S³L)/Frequency Input**
 - 7: V+: +5 VDC out to sensor (black wire)
 - 8: DATA: Input signal from sensor (red wire)
 - 9: GND: Sensor ground (white wire)
 - 10: SHLD: Cable shield

Power

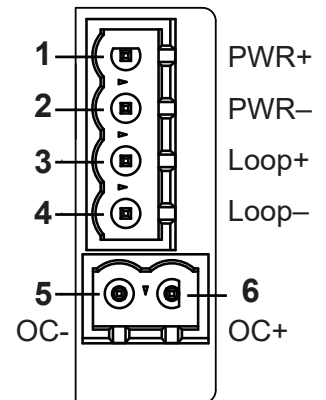

Digital (S³L)/Freq

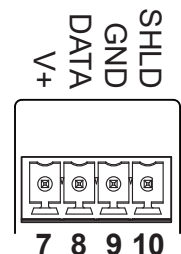

Sensor Wiring

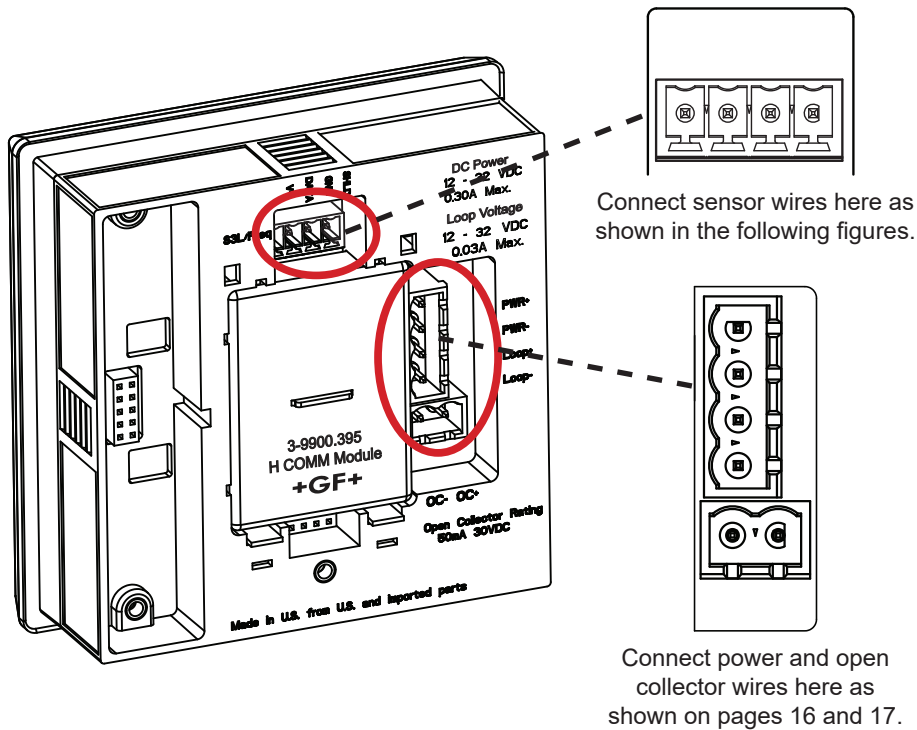

Loop powered systems cannot power both an H COMM Module and pH/ORP sensor.

If using both an H COMM Module and pH/ORP sensor, DC power is required.



Loop Power can be used ONLY for the following sensors:

515/8510, 525, 2250, 2350, 2450, 2536/8512, 2540 and 8058

All other measurement sensors require DC power.



Advanced 2751 features require Gen 4 or greater

Sensor Model	Freq Output	Digital (S ³ L) Output	Run on Loop Power	9900 Generation				
				I	II	III	IV	V
515/8510	X		X	X	X	X	X	X
525	X		X	X	X	X	X	X
2000	X			X	X	X	X	X
2100	X			X	X	X	X	X
2250		X	X	X	X	X	X	X
2350		X	X	X	X	X	X	X
2450		X	X	X	X	X	X	X
2507	X			X	X	X	X	X
2536/8512	X		X	X	X	X	X	X
2537-5		X		X	X	X	X	X
2540	X		X	X	X	X	X	X
2551	X	X		X	X	X	X	X
2552	X	X		X	X	X	X	X
258X	X	X		X	X	X	X	X
2724-2726		X		X	X	X	X	X
2734-2736		X		X	X	X	X	X
2751		X		X	X	X	X	X
2756-2757		X		X	X	X	X	X
2764-2767		X		X	X	X	X	X
2774-2777		X		X	X	X	X	X
2819-2823		X		X	X	X	X	X
2839-2842		X		X	X	X	X	X
2850		X		X	X	X	X	X
U1000	X			X	X	X	X	X
U3000	X			X	X	X	X	X
U4000	X			X	X	X	X	X

Sensor Wiring

NOTE: Loop Power cannot be used to power Signet models 2000, 2100, 2507, 2537, 2551 or 2552 Flow sensors.

Wiring for:

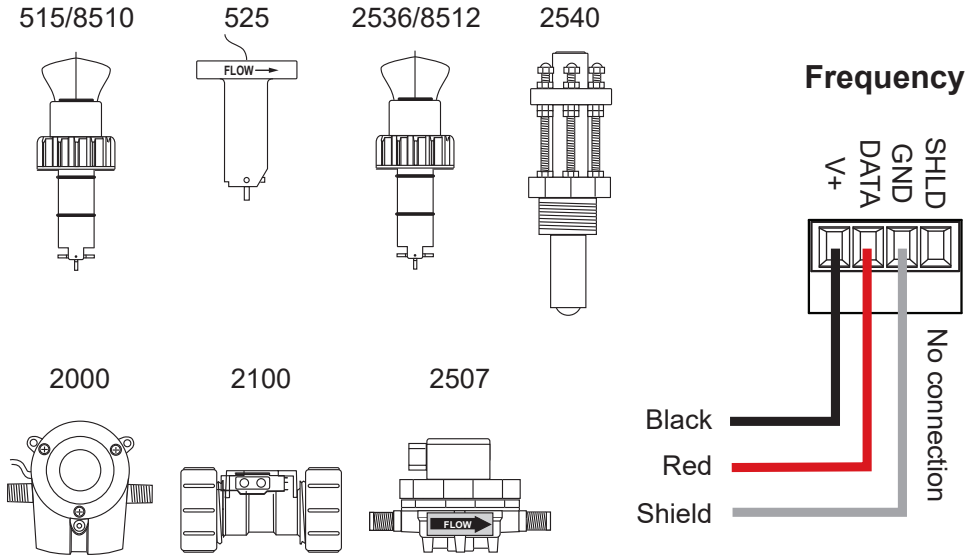

Technical Notes:

- See corresponding product manuals for maximum cable length.
- Maintain cable shield through cable splice.
- Route sensor cable away from AC power lines.
- 515/8510 and 525 installations, connect the silver (shield) wire to earth ground in case of EMI noise interference.



Technical Notes:

- Wiring terminals on the 2537 are rated for 16 to 22 AWG wires.
- The cable must be 7 mm to 10 mm in diameter (0.275 in. to 0.394 in.) to seal properly in the liquid-tight connector.
- The conduit ports have 1/2-inch NPT threads. After routing the cables, seal the port with a liquid-tight conduit connector (3-9000.392-1) or with conduit.
- The 2537 models can connect to the 9900 via a relay frequency signal or with a Digital (S³L) output. Signet recommends installing the Digital (S³L) output model (2537-5) because Digital (S³L) is more accurate.
- See 2537 instruction manual for additional installation information.

Wiring for:

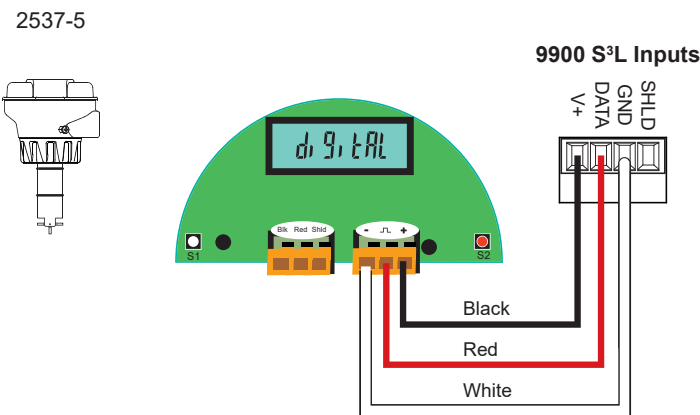

Sensor Wiring

Wiring for:

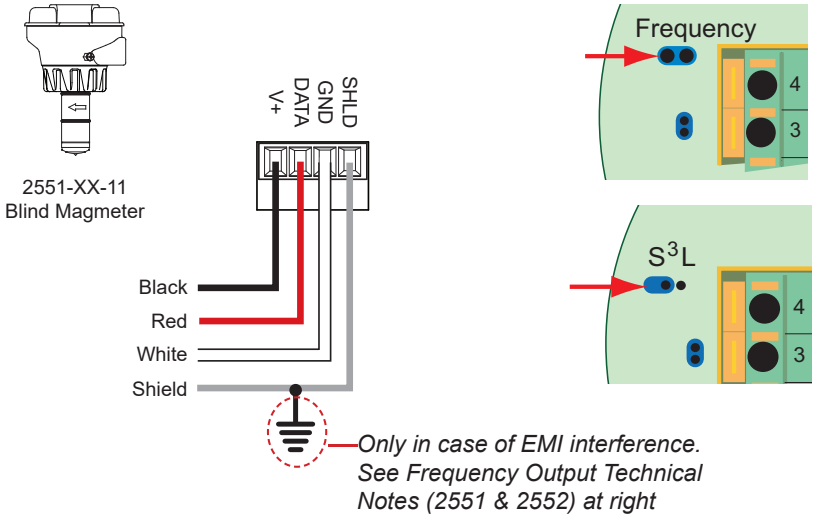

2551 Technical Notes:

- When the blue jumper illustrated here is placed over both pins, the 2551-XX-11 (Blind Magmeter) outputs an open collector frequency signal. When the jumper is removed (or placed over one pin for storage) the 2551-XX-11 outputs a digital (S³L) signal (recommended).

Input Wiring for 2551, 2552, and 258X Sensors

- Either Frequency or Digital (S³L) may be used.
- Signet recommends configuring these sensors with the Digital (S³L) output because it is more accurate and will also display reverse flow (negative numbers).**
- Input type is selected by choosing between "SENSOR FREQ" and "SENSOR S3L" in the FLOW sensor type INPUT menu (see page 32).
- Loop Power cannot be used to power the 2551 or 2552 sensors. The 258X requires an external power supply.

Wiring for:

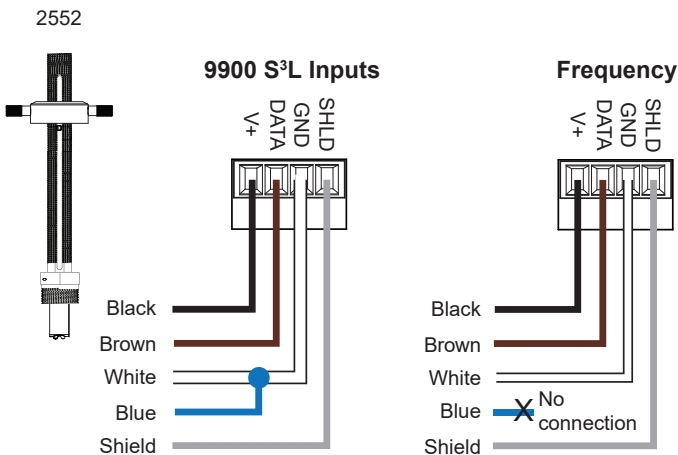

Frequency Output Technical Notes (2551 & 2552):

- The frequency output will be displayed as positive flow regardless of the flow direction.
- 5 VDC power required by the 2551 & 2552 is supplied by the 9900. No additional power is required.
- Connect the silver wire (shield) to earth ground in case of EMI noise interference.
- If EMI noise interference continues, disconnect silver wire (shield) from 9900

Wiring for:

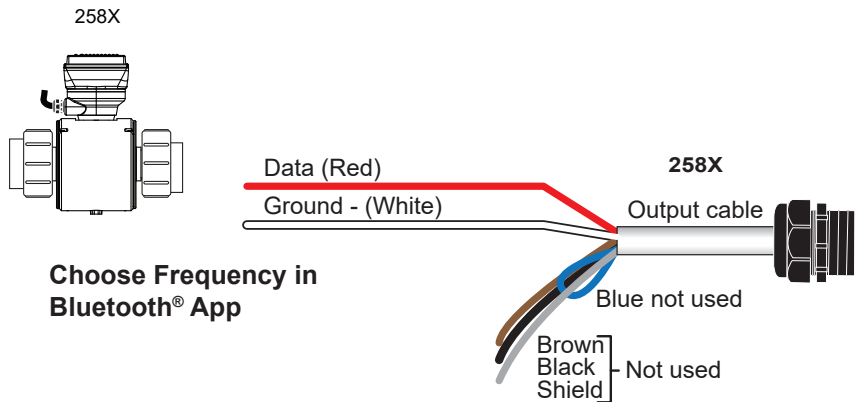

Choose Frequency in
Bluetooth® App

2552 Technical Notes:

- The 2552 outputs an open collector frequency signal that can be connected to the 9900.

Sensor Wiring

Wiring for:

2250

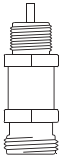

2350

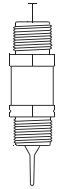

2450



2551*

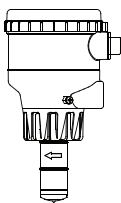

* 2551-XX-21, -41
Display Magmeter

2751

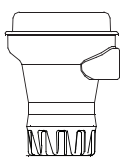

2850

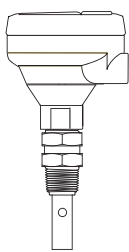

NOTE: The 2850 has no SHIELD wire.

9900 S³L Inputs

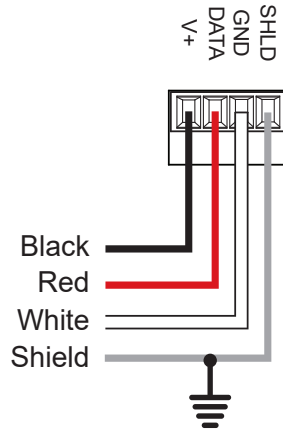

Technical Notes:

- Use three conductor shielded cable for sensor cable splices up to 305 m (1000 ft) max.
- Maintain cable shield through cable splice.
- Route sensor cable away from AC power lines.
- Connect the silver (shield) wire to earth ground in case of EMI noise interference.

Technical Notes:

- The 2850 has no SHIELD wire.
- To work correctly with the 9900, the 2850 must be set for the custom cell constant or the actual probe cell constant and the 9900 set for a 1.0 cell constant.

Wiring for:

8058-1



8058-1
close-up

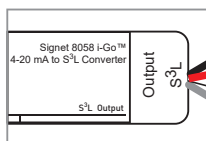

9900 S³L Inputs

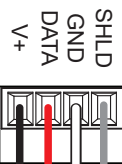

8058-2

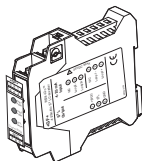

8058-2
close-up

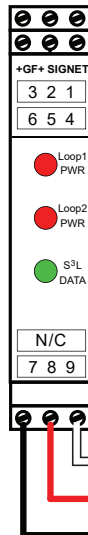

9900 S³L Inputs



Technical Notes:

- The cable length from the 8058 to the 9900 must not exceed 60 m (200 ft).
- When using the 8058-2, connect the loop source to Channel 1 input ONLY.
- See the 8058 manual for more information.

Sensor Wiring

Wiring for:

2610-51

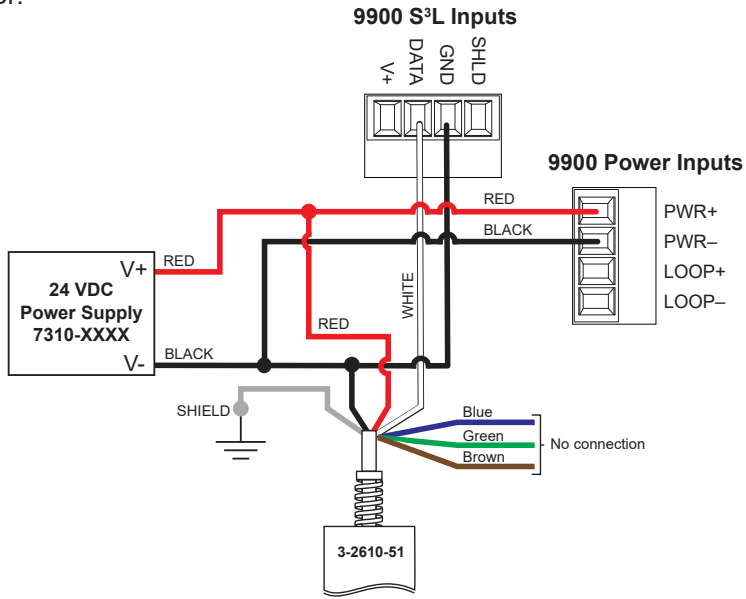

Technical Notes:

The wiring of the 3-2610-51 is non-standard:

- RED is 12 to 24 VDC
- WHITE is Data
- BLACK is VDC Ground
- A jumper MUST be installed between PWR- and S³L GND.



CAUTION!
DO NOT connect your 9900 to AC power
The 9900 MUST be powered by
10.8 to 35.2 VDC ONLY



Stand-alone application, no current loop used

ProcessPro
(for reference only)

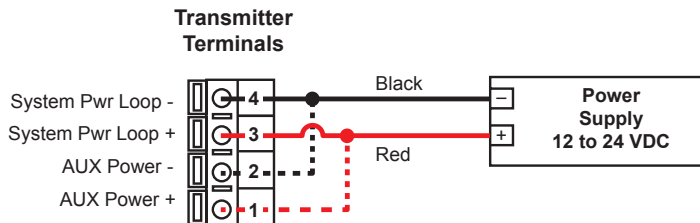

9900

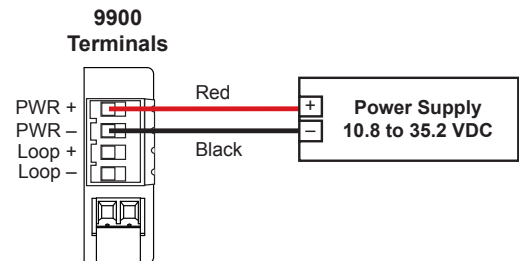

Connection to a PLC/Recorder, separate supply

ProcessPro
(for reference only)

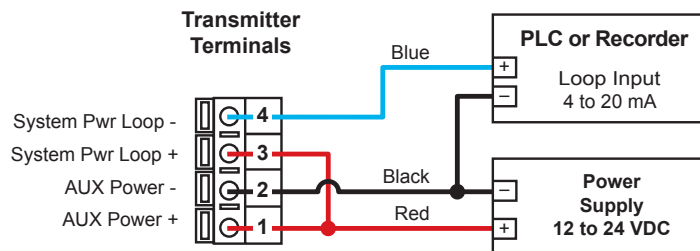

9900

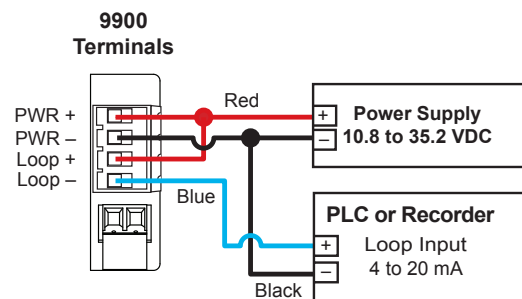

AUX power required for all 8750-2 systems

Loop Powered

ProcessPro
(for reference only)

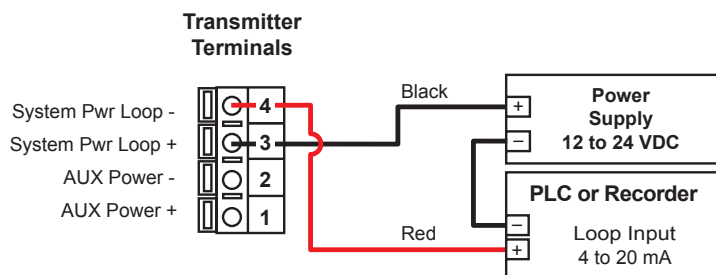

9900

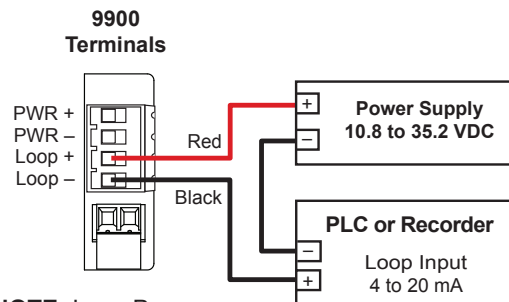

NOTE: Loop Power cannot be used to power certain Signet sensors. See table on page 11.

Open Collector Wiring

NPN Style Wiring

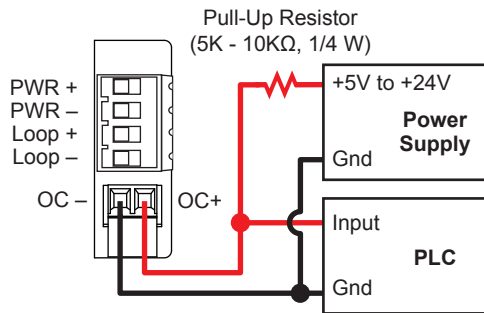

If PLC needs 0 logic input when relay is not energized, set NORMAL to CLOSED in the RELAY menu when using the Open Collector (R1) with NPN style wiring.

PNP Style Wiring

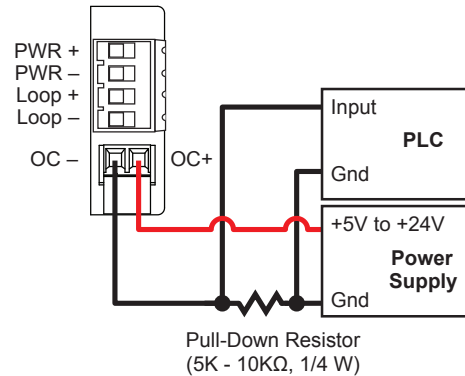

with NORMAL set to OPEN

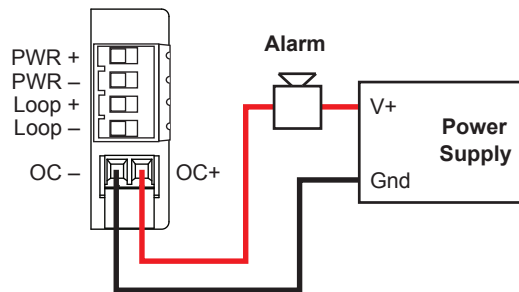

- The 9900 Open Collector (R1) output provides high-speed switching capability. Signal frequencies can reach 400 pulses per minute.
- The 9900 Open Collector (R1) output connection is dependent upon the type of circuit being controlled by the output.
- Most indicating instruments or control system inputs require a signal voltage of 0 to 5 V (TTL or CMOS logic levels) or 0 to 24 V. Therefore, the 9900 Open Collector output circuits must be equipped with a pull-up or pull-down resistor (not supplied), and a quality regulated 5 to 24 V (depending on the application) power supply (not supplied) is recommended to function properly.

Relay Module Wiring

The alarm is OFF during normal operation, and will go ON when relay energizes according to 9900 Relay settings.

The valve is ON during normal operation, and will go OFF when relay energizes according to 9900 Relay settings.

NO = normally open (closes when energized)
NC = normally closed (opens when energized)

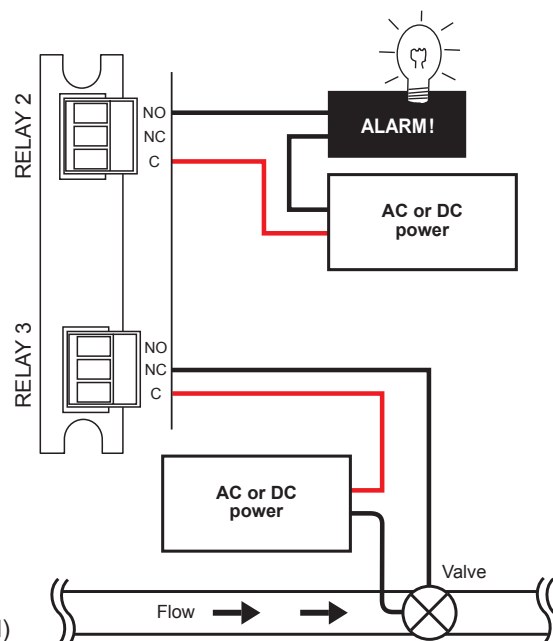

Relay Functions

System Start-up: Step 3

Set your relay functions to your own application requirements

Next step: System Setup (see page 24)



Once a setting is saved it becomes immediately active.

1. Go to the Relay Menu (RELAY flashing on screen, press ENTER).
2. If prompted, select desired source.
3. Press ▼ to relay **MODE** selection screen.
4. If necessary, press ► and then ▼ or ▲ to select **R1 MODE LOW**. Press ENTER to confirm.
5. Press ▼ to **R1 SET LOW**. Press ► to enter GPM value of 5.5.
6. Press ENTER to save.
7. Scroll ▼ to the **R1 HYSTERESIS** menu.
8. Press ► to edit.
9. Set the hysteresis for this relay. This affects the turn off only: **2.5 gpm**.
10. Press ENTER.
11. Scroll down ▼ to the **R1 ON DELAY** menu.
12. Press ► to edit.
13. Set the turn-on delay in seconds for the relay: **15.0**.
14. Press ENTER.
15. Exit to View Mode. ▲▼ ▲▼

- Relay function can be tested in the RELAY menu.



Example: Set a relay R1 to turn on at a low setpoint of 5.5 gpm with a time delay of 15 seconds and turn off at 8.0 gpm.

Remember,
SET LOW + hysteresis = OFF point:
5.5 + 2.5 = 8.0

Relay and Open Collector Outputs

RELAY HIGH and LOW Settings

Depending on the desired function of the circuit attached to the Open Collector (R1) output, it may be necessary to have the Open Collector turned “on” or “off” when the criteria for the activation of this output are met.

If the 9900 is set to operate in RELAY LOW mode, when the user-defined condition for the activation is met (e.g. exceeding an alarm limit) the Open Collector switch is turned “on.” If wired as standard “NPN-style” output (see previous page) the logic level of the attached control system or PLC input consequently becomes “low” logic level (when NORMAL is set to OPEN).

If a high input logic level is required for activation, it can be accomplished in one of three ways.

In order of preference,

1. Change the Open Collector (Relay 1) output function to “high” in the instrument's RELAY menu, or
2. Wire the Open Collector (R1) output “PNP” style as described on the previous page, or
3. Set the Open Collector (R1) to NORMAL CLOSED in the RELAY menu.

Fail-Safe Behavior

No matter the setting, the Open Collector output turns off if the 9900 loses power. This must be taken into account when evaluating system failure consequences. If the system layout requires a “closed” or “on” condition for the output in case of power loss, a mechanical dry-contact relay (NC contacts) must be used instead of the Open Collector (R1) output.

Voltage and Current Limitation

The supply voltage in the Open Collector output circuit **MUST** be limited to the specified maximum Open Collector voltage (see operating manual for specific instrument). The use of a quality 5 to 24 V (depending on the application) regulated power supply (not supplied) is recommended.

The current through the Open Collector switch also must be limited. Typical Open Collector outputs allow only for 10 to 50 mA switch current. Exceeding this current limit can burn out the Open Collector output components immediately.

Load and Pull-Up/Down Resistor Considerations

By utilizing basic arithmetic and Ohm's Law, the safe limits of load resistance can be determined. When the Open Collector switch is closed, almost the entire supply voltage is applied to the load (e.g., the pull-up or pull-down resistor, the alarm horn input, a potential power relay coil or annunciator lamp). The resulting current through the load and through the Open Collector switch, as well, can be calculated as:

$$(\text{Current}) = (\text{Supply Voltage}) / (\text{Load Resistance})$$

Relay Outputs

The 9900 open collector and relays are selectable and configurable and can be used as switches that respond when the process value moves above or below a user-defined setpoint or it can be used to generate a pulse at a rate proportional to the process value.

They can be used for Low Alarm, High Alarm or Proportional Pulse triggering related to the process value. All relay functions are set up in the RELAY menus.

- ◇ Relay energized
- ◆ Relay de-energized

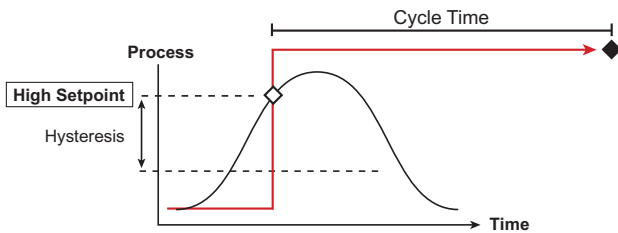
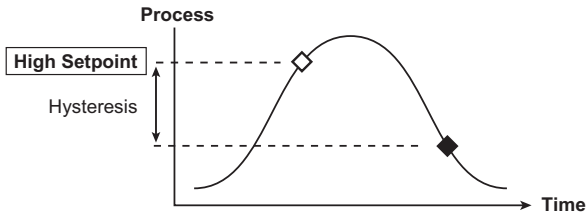
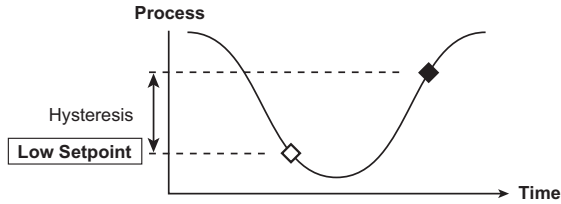

- ◇ Relay energized
- ◆ Relay de-energized



CAUTION!

If power is lost to the 9900 Transmitter during a cycle, the Cycle Time will reset. If the condition still exists after power is restored, the relay will be energized for the complete Cycle Time.

Open Collector Output

- Longer life than a mechanical relay
- No moving parts
- Faster ON/OFF switching capabilities than mechanical relays
- Can switch DC voltage only (< 30 VDC)
- Not recommended for use with inductive loads

◇ Low Setpoint:

Relay is on when the measured value is less than the setpoint.

◇ High Setpoint:

Relay is on when the measured value is higher than the setpoint.

┌ Cycle High/Low:

The relay can stay energized for a set length of time after the process value goes above (or below) the setpoint. The relay will stay on for the CYCLE TIME and then turn off, even if the process value is still above (or below) the setpoint. The cycle will not repeat until the process value goes below (or above) the setpoint minus the hysteresis after the relay times out.

In FLOW, Cycle High activates the relay each time the volume reaches the SET VOLUME setpoint (see page 27).

NOTE: To reset the timer (or volume in Flow): in the RELAY menu, select TEST RELAY function. The timer will reset to 0 if the condition no longer exists when the TEST is performed. The timer will restart if the condition still exists.

Relay Outputs

◆ Window In/Out:

Relay is on when the value is higher or lower than the high or low setpoint.

WINDow IN = relay on if measurement is inside the window of two setpoints. Measurement inside the two setpoints is abnormal condition.

WINDow OUT = relay on if measurement is outside the window of two setpoints.

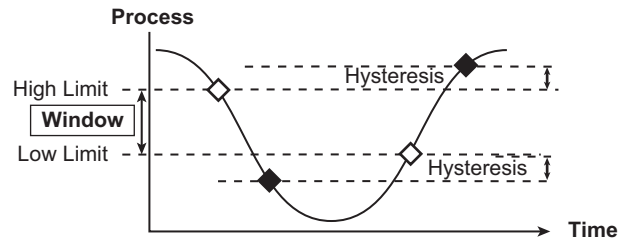

Window IN example

- ◇ Relay energized
- ◆ Relay de-energized

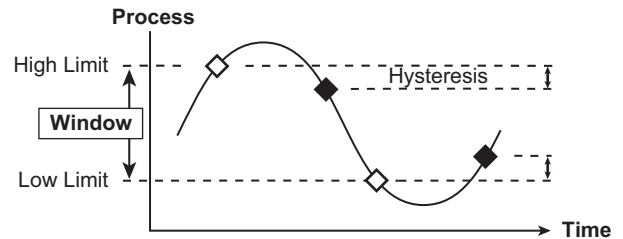

Window OUT example

▭▭ Proportional Pulse Operation:

The transmitter can output a pulse at the rate defined by the settings in the CAL menu and the sensor input. The maximum pulse output from the relays is 300 pulses per minute. Example usage would be to control solenoid-operated dosing pumps.

For example: As the process value drops below the setpoint, the output will start pulsing in relation to the process value, the maximum pulse endpoint and the programmed pulses/minute. The pulse rate will change as the process value changes and approaches the programmed endpoint. This functionality can be used to precisely control the process.

The starting point, endpoint and maximum pulse rate are selectable in the RELAY menus.

NOTE: Relay LEDs are not lit in PULSE mode

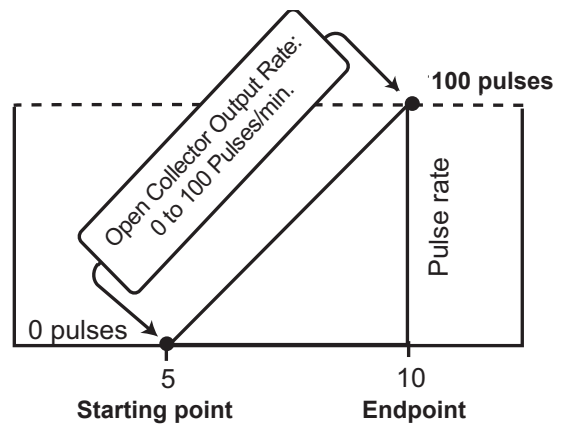

In the example:

- The output will be 0 pulses/min. when value is less than 5.
- The output will be 50 pulses/min. when value is 7.5.
- The output will be 100 pulses/min. when value is greater than 10.

Relay Outputs

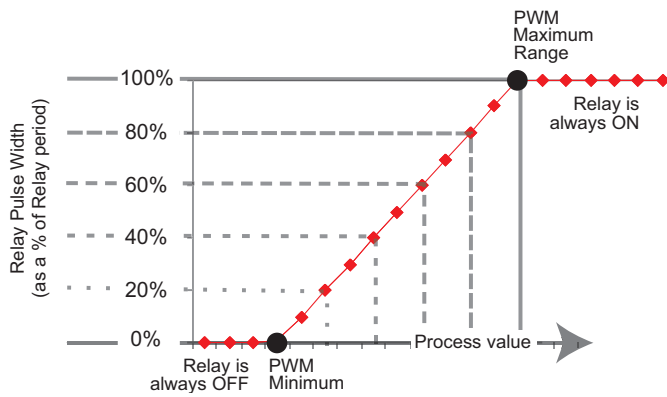

• Pulse Width Modulation

PWM automatically varies the ratio of ON time to OFF time proportional to minimum and maximum range settings.

The relay period is the sum of the time a relay is ON and the time it is OFF.

Relay pulse width is the time the relay is ON.

The 9900 must be programmed with the relay period, and with the low and high setpoints.

NOTE: The PWM mode is not used for Pressure applications.

NOTE: Relay LEDs are not lit in PWM mode.

Example:

- The pulse width will be 0% of the relay period (relay always OFF) when the process value is less than the minimum range.
- The pulse width will be 100% of the relay period (relay always ON) when the process value is greater than the maximum range.
- The pulse width will be 60% of the relay period when the process value is at 60% of the span between the minimum and maximum range.

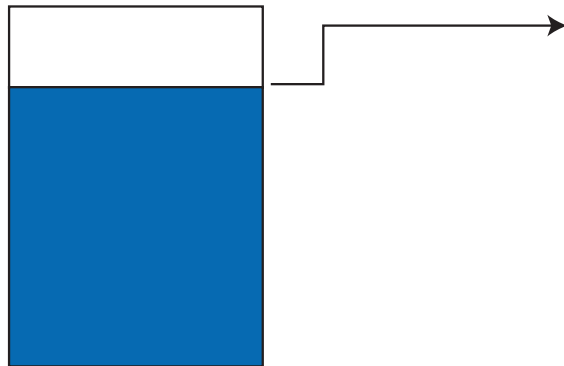
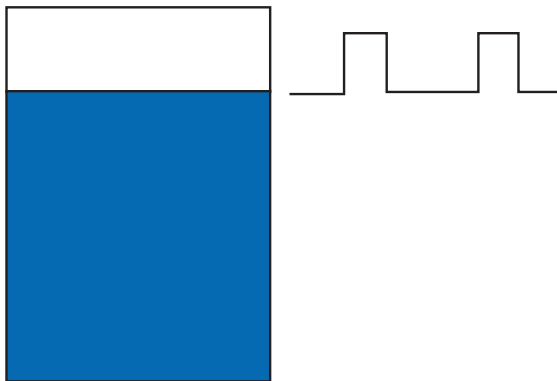

• Volumetric Pulse

A pulse is generated each time a specified volume of fluid is registered. For flow inputs only.

NOTE: Relay LEDs are not lit in VOLUMETRIC PULSE mode

• Totalizer Volume

Relay activates and latches when a specified volume of fluid is registered. For Flow inputs only.

Total Volume mode counts the TOTALIZER Units until the setpoint volume is reached, then turns on the relay until the resettable totalizer is reset.

If the Resettable Totalizer reading is greater than the setpoint, the relay will be turned on immediately. The relay will be off when the totalizer is reset to zero.

This mode is useful to trigger a reminder when a process is due, as for a backwash cycle or filter change.

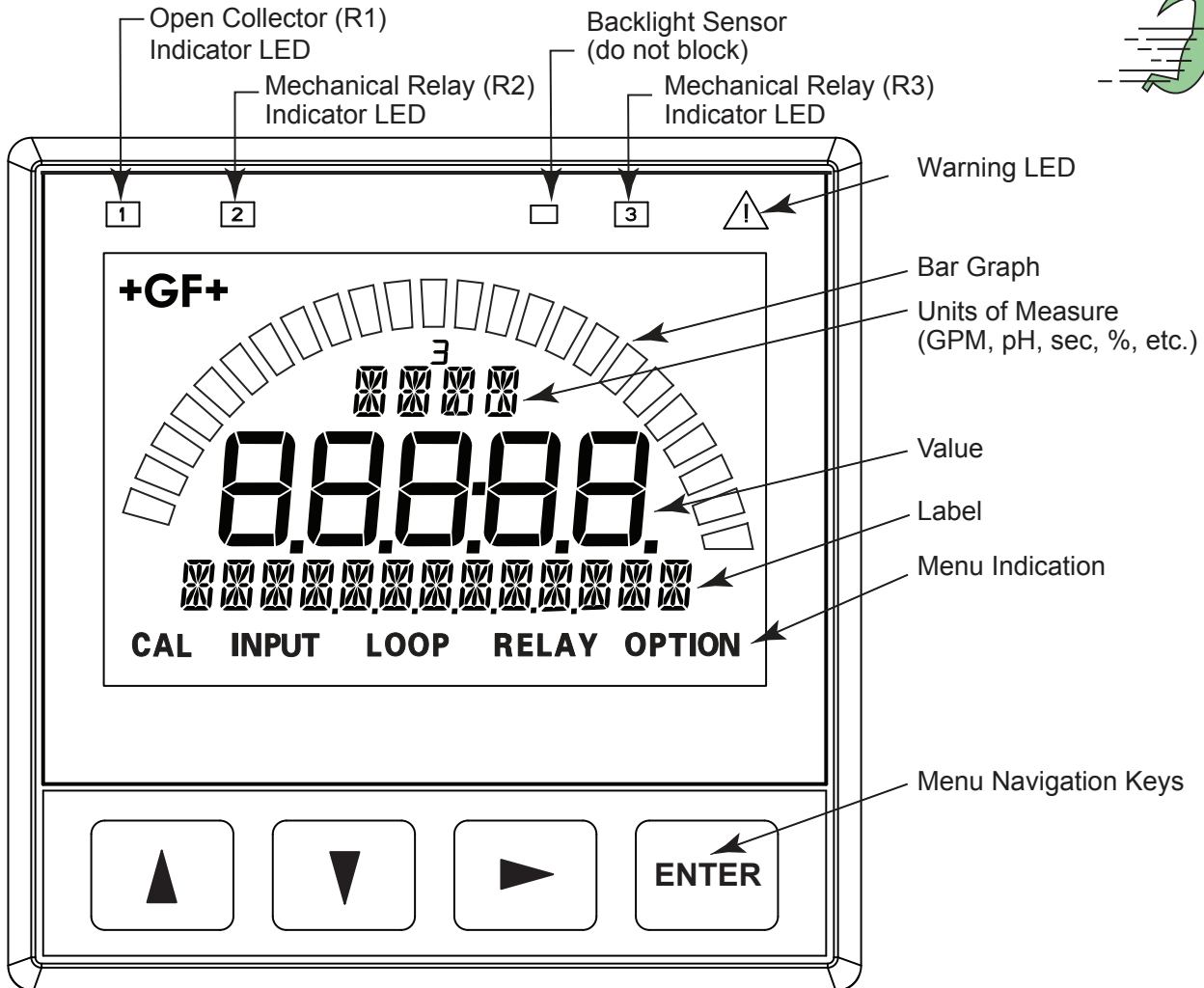

All possible segments shown in this illustration. The instrument's software controls which segments are shown at any particular time. Only the bar graph and GF logo are visible when the unit is turned off.

Warning LED will be lit when No Sensor or Wrong Sensor is detected in Digital (S²L) mode.

UP, DOWN keys

Scroll through Menu options or adjust values during editing
Press both together to exit a menu or escape without saving

RIGHT key

Select item or character to edit

ENTER key

Access menus
Save changes

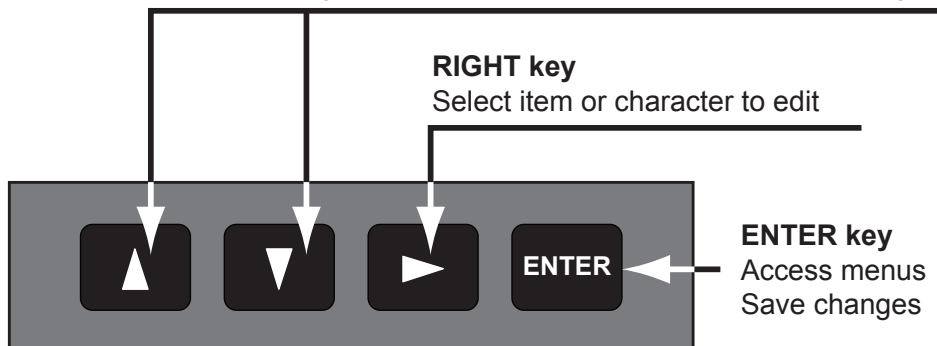

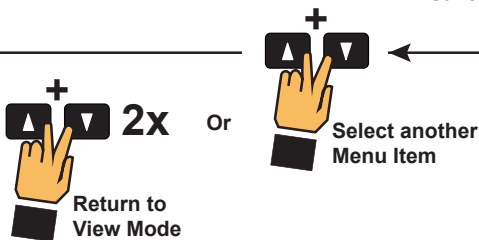
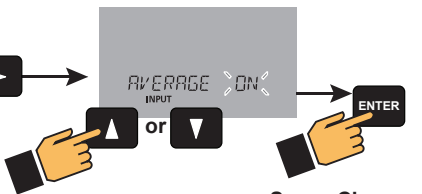
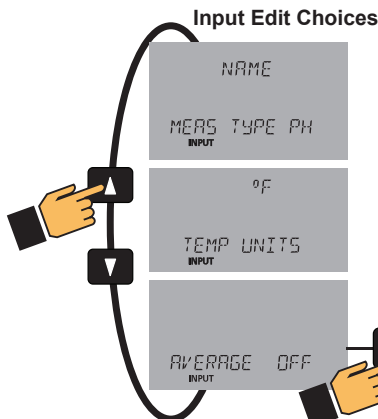
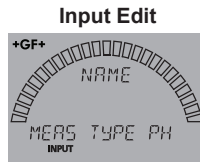
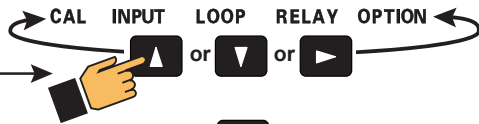
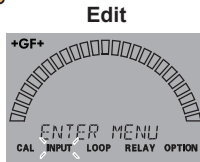
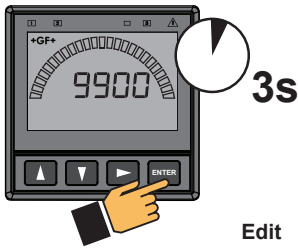

Keypad Functions

The four buttons of the keypad are used to navigate display modes according to the descriptions in this table. Notice that the function of each button may change depending on the display mode.

System Setup: Menu Navigation

This basic operating procedure repeats throughout the 9900 program:

1. Press ENTER for 3 seconds to enter MENU mode.
2. Press ► to move to the desired menu then press ENTER to select it. (Password may be required.)
3. Press ▲ or ▼ to select the desired menu item for editing.
4. Press ► to edit the value/selection.
5. Press ENTER to store the new value/selection.
6. Press ▲ or ▼ to select another menu item if desired. Repeat steps 3-5 as required.
7. Press ▲+▼ to select a different menu to edit. Repeat steps 2-5 as required.
8. When finished editing all menus, press ▲+▼ again to return to normal operation.

The menu is constructed in a loop, so you can move forward and backward to select an item. After any item is saved (by pressing ENTER), the display will return to the previous menu.

System Setup Menu

All of the basic system setup functions are automated in the 9900 for many sensors and sensor electronics. This includes identifying the sensor connected to the 9900, and configuring the display for the sensor. After installation and wiring is completed, apply power to the 9900.

When the 9900 is first powered on, it will attempt to determine the sensor type connected when ENTER is pressed (unit will display LOOKING FOR).

If no sensor is attached to the 9900, the words "TYPE" and "FLOW" are displayed.

If the 9900 does not identify your sensor type correctly, use the ▲ and ▼ keys to select your sensor type.

As you scroll through the available sensor types, press ► to select the desired sensor and then press ENTER.

You may change sensor type after initial power-on (if the sensor type is changed after your 9900 is already in service).

Enter the INPUT menu, scroll to TYPE, press ►, and scroll to select the desired sensor type (you may be prompted for your password).

Press ENTER. The bottom line will display ALL SETTINGS WILL BE RESET. ARE YOU SURE? The top line of the display will blink NO (unless switching from Factory mode). Press ▼ or ▲ to select YES.

Press **ENTER** again to finalize your selection.

NOTE: User is **strongly** discouraged from changing the sensor type away from the correct sensor.

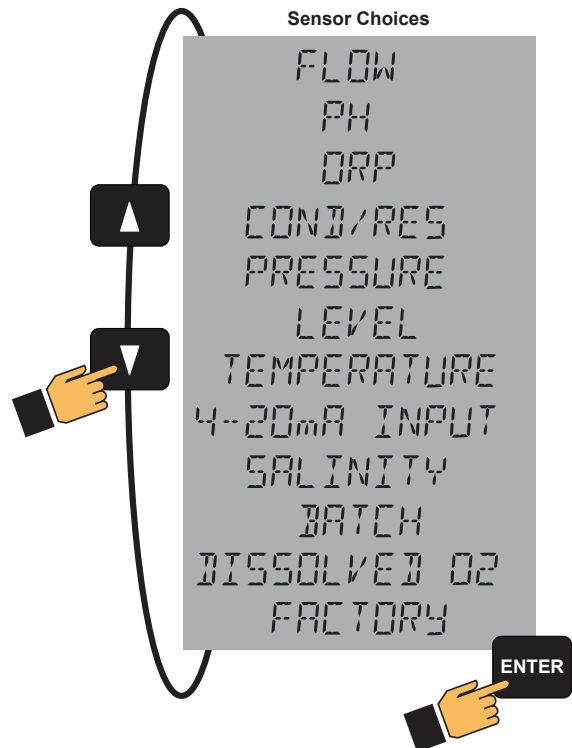
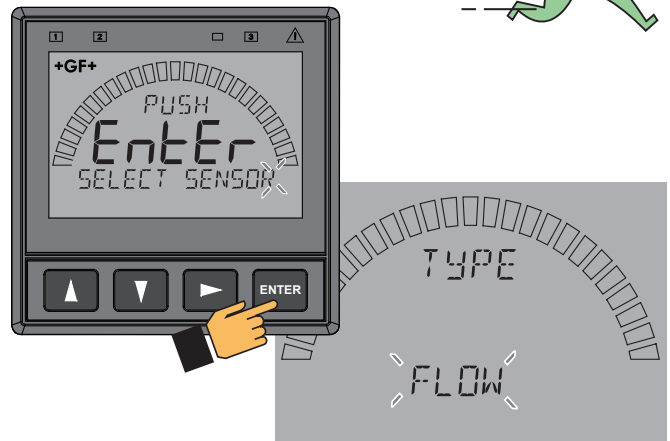

NOTE:
The 9900 displays the BATCH instrument type ONLY if the Batch Module is installed.

VIEW Mode Overview

The top level of menus is referred to as the **VIEW Mode**. This view displays measurement values as well as current outputs and relay status. The radial bar graph represents the measurement value that is also displayed in the 7-segment numeric field below the bar graph. The bar graph is primarily used to display the full scale range of the sensor, but can be scaled via a menu item.

During normal operation, the 9900 displays the VIEW mode.

- To select a display, press the ▲ or ▼ arrow keys. The display selections scroll in a continuous loop.
- Changing the display selection does not interrupt system operations.
- No password is necessary to change display selection.
- Output settings cannot be edited from the View Mode.
- The display will return to the VIEW mode if no button is pressed for 10 minutes.

MENU Mode Overview

The MENU mode enables the user to view and configure all menu items. The five menus available are: **CAL**, **INPUT**, **LOOP**, **RELAY**, and **OPTION**.

MENU Mode is entered by pressing and holding ENTER for three seconds.

The ► button is used to change the position of the blinking cursor. When the desired menu is blinking, press ENTER.

In the selected menu, use the ▲ and ▼ keys to navigate through the menu. Use the ▲, ▼ and ► keys to edit the selected item. (see Menu Navigation discussion, page 24)

To save the new selection, press the **ENTER** key. A message displaying “Saving...” will be displayed for 3 seconds. After this message is displayed, the newly selected value will be displayed, if applicable.

Password Overview

The password is often required to start editing. Once entered correctly, this password will not be needed for subsequent edits. However, once the menu system is exited, the password will again be required when edit mode is re-entered.

Your choice of password (STD or CODE) is selected in the Options Mode.

- **STD**
The standard (STD) password is ▲▲▲▼, pressed in sequence. This password is designed to protect the 9900 from unintentional changes. It is best suited for systems where a group of people need to be able to change settings.
- **CODE**
The CODE default setting is 0000, adjustable to any 4-digit numerical code up to 9999. Using a personal code provides the maximum degree of security. This code can be modified in the Options mode.

Error Handling

Errors occurring while in the VIEW Mode show a specific message (e.g., CHECK SENSOR). This message is displayed every 10 seconds and stays on for 5 seconds. Once the error is resolved or cleared, the error message stops.

Scrolling

In some cases, more than one message or measurement may need to be displayed. This is accomplished by alternating the message portions across the screen.



In the MENU mode, if the wrong code or password is entered, an ERROR message is displayed.



To change your CODE, go to OPTIONS mode, enter your desired code and press ENTER. (The STD password cannot be changed.)



System Start-up: Step 4

Customize your 9900 to your own installed sensors.

Common Menus

The menu system shares certain modes between sensor types.

The following describes the EDIT Mode menus found in common between most sensor types.



NOTE:

Menu and Mode displays shown are examples only.

Your displays may vary.

INPUT Menu

TYPE
DISSOLVED 02

(ALL) Manually select Sensor Type (See page 26 for further instruction).

Allows user to reset 9900 Transmitter to Factory settings.

Note: User is strongly discouraged from changing the sensor type away from the correct sensor.

LOOP Menu

The following can individually be set for each current loop

(Loop1 = 9900 base unit, Loop2 = Output Module)

00000
L1 SRC

(pH, COND/RES, LEVEL, SALINITY, DO only)

Set LOOP output source; select between Primary and Secondary measurements of applicable sensor.

Secondary measurements: DO, pH, COND/RES, and SALINITY = TEMP; LEVEL = VOL.

L1 MODE LIN

(COND/RES only) Select LIN/LOG. Default = LIN.

See LOG Current LOOP Output discussion in Appendix.

00000
L1 4mA SETPT

(ALL) Set value corresponding to desired 4 mA output. 5 digits max. Default = 0 (ORP = -999).

00000
L1 20mA SETPT

(ALL) Set value corresponding to desired 20 mA output. 5 digits max.

Defaults = 100 (Flow, Cond/Res, Temp), 14 (pH), 1000 (ORP), 10 (Lvl/Prs), 5 (4 to 20 mA), 80 (Sal).

mA
3.6
L1 ERR VALUE

(ALL) Set desired LOOP output value when sensor error (e.g., bad sensor, broken wire) is detected.

Select (3.6 mA, 22 mA). Default = 22.

mA
4.00
L1 ADJ 4mA

(ALL) Allows fine-tuning to compensate for errors in other equipment connected to the 9900.

Adjust the minimum and maximum current output. The display value represents the precise current output.

Adjustment limits: from 3.80 mA minimum to 5.00 mA maximum. Default = 4.00 mA.

mA
20.00
L1 ADJ 20mA

(ALL) Allows fine-tuning to compensate for errors in other equipment connected to the 9900. Adjust

the minimum and maximum current output. The display value represents the precise current output.

Adjustment limits: from 19.00 mA minimum to 21.00 mA maximum. Default = 20 mA.

mA
3.80
L1 TEST LOOP

(ALL) Press ▲ or ▼ to manually order any output current value from 3.8 mA to 21.00 mA to test the output of LOOP.

Common Menus

RELAY Menu

The following can individually be set for each relay (R1 = open collector, R2/R3 = Relay Module)

(pH, LEVEL/VOL, COND/RES, SALINITY and DO only.) Select source for each of R1, R2 and R3 outputs. Choose pH/TEMP, LEVEL/VOLUME, COND/TEMP, SAL/TEMP, (DO)/TEMP.

SOURCE 000000

Defaults = pH, COND, LEVEL, SAL, PPM.

Important: Review all set point and hysteresis settings when the source for a relay is changed.

NORMAL OPEN

(ALL) Set Open Collector (R1) as Normally Open or Normally Closed. Default = OPEN.

R 1

MODE OFF

(ALL) Select the desired mode of operation for the open-collector (R1) output (OFF, LOW, HIGH, WINDow IN, WINDow OUT, CYC LOW (except FLOW), CYC HIGH, PROP PuLSe, VOL PuLSe, PWM, TOTAL, USP, ERROR mode) (See chart on page 29). Default = OFF. Continue stepping through to select R2 and R3 output modes. When MODE is set to ERROR, delays energizing relay until after ON DELAY time expires if sensor problem is detected. See Cycle High/Low discussion on page 20.

00000
R 1 SET LOW

(ALL) (Shown if LOW, WIND IN/OUT or CYC LOW mode)

Relay turns on if process measurement goes lower than this value. Set desired value.

NOTE: The corresponding indicator lights do not light up in PROP PLS and PWM modes. The LEDs light up only when the Test Relay options are selected.

10000
R 1 SET HIGH

(ALL) (Shown if HIGH, WIND IN/OUT or CYC HIGH mode)

Relay turns on if process measurement goes higher than this value. Set desired value.

NOTE: The corresponding indicator lights do not light up in PROP PLS and PWM modes. The LEDs light up only when the Test Relay options are selected.

10000
R 1 SET VOLUME

(FLOW only) (Shown if CYC HIGH FLOW or VOL PLS mode)

Amount of accumulated flow that must be counted before a pulse is sent out.

Relay turns on if flow volume exceeds this value. Set desired value. Default = 100.00.

00000
R 1 HYSTERESIS

(ALL) (Shown if LOW, HIGH, WIND IN/OUT, CYC LOW/HIGH or USP mode)

Hysteresis prevents the system from chattering around the set point.

Set amount (in units of measure from INPUT Mode) to add to SET LOW or SET HIGH values.

100
R 1 USP PERCENT

(COND/RES only) (Shown only in USP mode)

Relay turns on if USP value drifts by this value away from USP limit.

See USP Limits discussion in the Appendix.

Important: Relay source must be set to Conductivity, do not use Temperature.

00000
R 1 ON DELAY

(ALL) (Shown if Low, High, WIND IN/OUT, CYC LOW/HIGH or Error mode)

Set seconds (up to 9999.9) to wait before activating relay.

00000
R 1 PULSE MIN

(ALL except PRESSURE) (Shown only if PROP PLS mode)

Set minimum setpoint value for proportional pulsing.

00000
R 1 PULSE MAX

(ALL except PRESSURE) (Shown only if PROP PLS mode)

Set maximum setpoint value for proportional pulsing.

P/m
00000
R 1 MAX RATE

(ALL except PRESSURE) (Shown only if PROP PLS mode)

Set desired maximum pulse rate (300 max)

00000
R 1 PWM MIN

(ALL except PRESSURE and FLOW) (Shown only if PWM mode)

Set minimum value for pulse width modulation.

00000
R 1 PWM MAX

(ALL except PRESSURE and FLOW) (Shown only if PWM mode)

Set maximum value for pulse width modulation.

NOTE: Defaults for most relay functions are dependent upon sensor type and are not listed here.

Common Menus

RELAY Menu *The following can individually be set for each relay (R1 = open collector, R2/R3 = Relay Module)*

SEC
00
R1 CYC TIME

(ALL) (Shown only if CYC LOW/HIGH mode)
Set time in seconds (up to 99999) for relay to remain on. See discussion on page 19.

G
10000
R1 PLS VOLUME

(FLOW only) (Shown only if VOL PULS mode)
Amount of accumulated flow that must be counted before a pulse is sent out. Set value.

SEC
0.1
R1 PLS WIDTH

(FLOW only) (Shown only if VOL PULS mode) Set time value for one pulse width.
Important: Do not set the Volume Pulse below 0.1 seconds.

SEC
00000
R1 PWM PERIOD

(ALL except PRESSURE and FLOW) (Shown only if PWM mode)
Set time value for one complete pulse cycle. (relay ON time + relay OFF time).

R1
tot
000 10000 VOL

(FLOW only) (Shown only if TOTAL) Resettable value that, when exceeded, turns relay on.
Must reset Totalizer (in VIEW Mode) to clear relay. Set maximum value.

R1 TEST RELAY

(ALL) Press ▲ or ▼ to turn relay on or off for testing purposes.
Can also be used to reset or latch/unlatch the relay. Does NOT reset the Totalizer.

Available Relay Modes by Sensor Type

	Flow	pH	ORP	Cond/Res	Pressure	Lvl/Vol	Temp	4 to 20 mA	Salinity	DO
Off	X	X	X	X	X	X	X	X	X	X
Low	X	X	X	X	X	X	X	X	X	X
High	X	X	X	X	X	X	X	X	X	X
Wind In	X	X	X	X	X	X	X	X	X	X
Wind Out	X	X	X	X	X	X	X	X	X	X
Cyc Low		X	X	X	X	X	X	X	X	X
Cyc High	X	X	X	X	X	X	X	X	X	X
Prop Pulse	X	X	X	X		X	X	X	X	X
Vol Pulse	X									
PWM		X	X	X		X	X	X	X	X
Total	X									
USP				X*						
Error	X	X	X	X	X	X	X	X	X	X

* In USP Relay Mode in Conductivity, Relay Source must be set to COND, TEMP COMP must be set to NONE and Unit Of Measure must be set to μ S.

Common Menus

OPTION Menu



Adjust the LCD contrast for best viewing for your environment. A setting of 1 is lowest contrast, 5 is highest. Default = 3



Select backlight level (OFF, LOW, HIGH, AUTO). Default = AUTO
NOTE: No backlight when operating on loop power.



Enter 5 digit value to represent bar at minimum. Default = 0 (ORP = -999)



Enter 5 digit value to represent bar at maximum. Defaults = 100 (Flow, Cond/Res, Temp), 14 (pH), 1000 (ORP), 10 (Lvl/Prs), 5 (4 to 20 mA), 80 (Sal), 20 (DO)



(ALL) Set the decimal to the best resolution for your application. The display will automatically scale up to this resolution. Select -----, -----. , ---.-, --.---, or -.---- (varies by parameter). Default = ----.-.



(pH, COND/RES, TEMP, SAL, DO only) Set the Temperature decimal to the best resolution for your application. The display will automatically scale up to this resolution. Select -----, -----. , or ---.-. Default = ----.-.



(FLOW only) Set the decimal to the best resolution for the Permanent Totalizer display. The display will automatically scale up to this resolution. Select -----, -----. , ---.- or --.---. Default = ----.-



(COND/RES only) Displays mS or μ S as set in COND UNITS in INPUT Mode. Set ON/OFF. Default = OFF



(FLOW only) Locks the TOTALIZER output. Select OFF, ON (Does not affect Permanent Totalizer). Default = OFF



(ALL) Select STD, CODE. Default = STD



(ALL) Enter desired password code. 4-character entry not displayed, ---- displayed instead. (Shown if type = CODE.)



(ALL) Enter 13-character string, if desired. Default = Blank

Modbus

The 9900 Modbus Module allows the 9900 to be connected to a serial Modbus RS485 network. The Modbus Module will allow PLCs and Scada Systems to query the current readings, channel status, and status of the 9900 and Modbus communications.

Default Communication Parameters

ModBus Address	34
ModBus Termination	Off
ModBus Mode	RTU
ModBus Baud Rate	19.2K
ModBus Parity	Even
ModBus Endian	Big

Modbus Menus

Modbus Menus are not displayed in Factory or Batch.

Note: 9900 Generation V or greater only

OPTION Menu

MODBUS
COMMUNICATION

Press the ► to change the settings of the Modbus Module.

Modbus Communication Settings Menus

MODBUS
34
ADDRESS

Set the Modbus address of the 9900.
The default address is 34.

OFF
TERMINATION

The 9900 Modbus Module has an electronic termination network.
The Termination can be activated by setting the value to ON.
The default value is OFF (the termination is OFF).

MODBUS
MODE RTU

Set the Modbus Communication Mode.
The default mode is RTU.

MODBUS
BAUD 192K

Set the baud rate of the Modbus network.
The default value is 19.2K baud, 19200 baud.

MODBUS
PARITY EVEN

Set the parity of the Modbus network.
The default value is Even parity.

MODBUS
BIG ENDIAN

Set the byte order in which the 9900 transmits floating point numbers in the Modbus protocol.
The default value is Big Endian.

NO
RESET DEFAULT

Reset all Modbus setting to the default values.

NO
ACTIVATE NOW

Activate setting to set the communication parameters to the new values.

OPTION Menu

NO
REMOTE SETUP

Enables Remote Setup to configure the 9900 via a computer and the optional 0252 Configuration tool.
Press ► and select YES to enable. REMOTE SETUP flashes when mode is enabled.
NOTE: Communication with 0252 tool is automatic when 9900 is in FACTORY state (Enter flashing).
Refer to the 0252 Configuration Tool manual, 3-0252.090, included with your configuration tool.

9900
GENERATION V

Displays Transmitter Generation Version.

Sensor-Specific Menus

The following pages list the sensor-specific settings for each sensor type.

Flow



This is the normal display and does not time out.



FLOW Setup Checklist

1. Make sure FLOW sensor type is selected (see System Setup Menu, page 24).
2. Set the Units of Measurement.
3. Set Sensor Type (Freq or S³L).
4. If LOOP is used, set the minimum and maximum 4 to 20 mA setpoints.
5. Set K-Factor (pulses per Unit Volume) from Flow Sensor manual.
6. Set Totalizer factor.
7. Set Last Cal Date and initials.
8. If desired, set up relay functions for your own application.

VIEW Mode Menu

	Display the flow rate and the resettable totalizer. Press ► to reset the totalizer. (If Reset is locked, enter the password first.) Lock or Unlock the totalizer in the OPTIONS menu. This is the resettable totalizer View display.
	Display the Permanent Totalizer value (note the "P" indicating Permanent). Pressing ► displays units of measure.
	Displays the 4 to 20 mA LOOP output.
	Bottom line shows one of three states (OFF, ON, PLS) for each of the three relays. Displays remaining time for CYC LOW or CYC HIGH mode. The relay(s) will remain ON while counting down. NOTE: (Reset the Timer) In the RELAY menu, select TEST RELAY function. The timer will reset to 0 if the condition no longer exists when the TEST is performed. The timer will restart if the condition still exists.

CAL Menu

NO
HOLD OUTPUTS

YES prevents relays from activating while making adjustments, and relays in PULSE mode will suspend pulsing. Output is held until the user exits the CAL menu. Select YES/NO.
Default = NO

KF 600000

Set K-Factor (pulses per unit volume) from Flow Sensor manual.
Min: 0.0001, max 999999. Cannot be zero. Default = 60.0000.

TF 1000

Sets the volume of each count of the Totalizer as a multiple of the volume unit of the K-Factor.
Min: 0.0001, max 999999. Cannot be zero. Default = 1.0000.

RATE CAL

Select to calibrate using Rate method (see Appendix).

VOLUME CAL

Select to calibrate using Volume method (see Appendix).

LAST
CAL
MM-DD-YYYY II

Enter date of calibration (mm-dd-yyyy) and initials of calibrator (ii).

INPUT Menu

NAME
FLOW

If desired, a custom name can be entered.
Enter 13-character string.
Default = FLOW

SENSOR FREQ

If your flow sensor is configured for frequency output, select FREQ.
If configured for Digital (S³L) output (recommended), select (S³L).
Default = FREQ

GPM
FLOW UNITS

Set the units of measure.
The last character sets the timebase: S (seconds) M (minutes) H (hours) D (days).
Default = GPM

TOT
Unit
GALLONS

Identifies the Totalizer units. It has no effect on any calculation.
Default = GALLONS

HART
2nd
TOT PERMANENT

(Only shown if HART or Modbus Module is installed. 9900 Gen IV, v.24-00 or later)
Select Permanent or Resettable Totalizer (as secondary value).

HART
2nd
TOT RESETTABL

NOTE: Totalizer units are transmitted as unit code 240 via HART or Modbus communication.

AVERAGE OFF

Dampens display, output and relay response rates.
Select Low, Med, High, OFF. (See discussion in Appendix.)
Default = OFF

SENSITIVITY

The Sensitivity setting determines how the 9900 responds to sudden changes in the flow rate. The value is expressed in units of measurement.
If the setting is exceeded, it "overrides" the Averaging function briefly to allow for the actual change in flow rate to be displayed. Averaging resumes shortly after.
The result is a smooth flow display and a quick response to large shifts in the flow rate. (See discussion in Appendix, page 51.)



This is the normal display and does not time out.



pH Setup Checklist

1. Make sure pH sensor type is selected (see System Setup Menu, page 24).
2. Set the Temperature Units ($^{\circ}\text{C}$ or $^{\circ}\text{F}$).
3. If LOOP is used, set the minimum and maximum 4 to 20 mA setpoints.
4. Perform calibration (EasyCal, Standard or Standard and Slope).
5. Set Last Cal Date and initials.
6. Select source for Open Collector and Relay output (pH or Temp).
7. If desired, set up relay functions for your own application.

VIEW Mode Menu

TEMP ----- $^{\circ}\text{C}$

Displays temperature at the sensor.

RAW ----- mV

Displays the millivolt input from the electrode. Use this display to determine the relative condition of your electrode during periodic calibration. (7 pH buffer = 0 mV, ± 50 mV)

MOHM
350
GLASS IMP -->

(2751 preamp only, 9900 Generation IV or greater) Displays last **AUTOMATED** or **MANUAL GLASS IMPEDANCE** measurement.

Press \blacktriangleright to MANUALLY measure GLASS IMPEDANCE.

AUTOMATED GLASS IMPEDANCE update time is set under the pH INPUT menu (see next page).

NOTE: While AUTOMATED/MANUAL GLASS IMPEDANCE measurement is in progress, all outputs are held and an "UPDATING" message will be displayed until the measurement is completed.

SENSOR DATA-->

(2751 preamp with memory chip enabled sensors only, 9900 Generation IV or greater)

Press \blacktriangleright to access sensor data stored in sensor memory chip.

NOTE: Pressing \blacktriangle + \blacktriangledown , or changing to a sensor without a memory chip, while viewing SENSOR DATA, will return the 9900 to the top VIEW mode display (current pH measurement).

S/n
6 140 122 1234

(2751 preamp with memory chip enabled sensors only, 9900 Generation IV or greater)

Sub-menu of stored sensor data, accessed by pressing \blacktriangleright on the above SENSOR DATA menu.

SENSOR DATA includes:

Sensor Serial Number (S/n), Sensor Model Number (MOD), pH Slope, pH Offset, Temperature Offset, Factory Reference Impedance, Total Usage Time (HRS), Minimum pH value measured (MIN PH), Maximum pH value measured (MAX PH), Minimum Temperature value measured (MIN TEMP), Maximum Temperature value measured (MAX TEMP).

LOOP 450 mA

Displays the 4 to 20 mA LOOP output.

RLYS
1 2 3
OFF OFF OFF

Bottom line shows one of three states (OFF, ON, PLS) for each of the three relays.

Displays remaining time for CYC LOW or CYC HIGH mode. The relay(s) will remain ON while counting down.

NOTE: (Reset the Timer) In the RELAY menu, select TEST RELAY function.

The timer will reset to 0 if the condition no longer exists when the TEST is performed.

The timer will restart if the condition still exists.

CAL Menu

<code>CAL</code> <code>AT INSTRUMENT</code>	Select AT SENSOR to perform calibration using the Signet 2751 sensor electronics. Select AT INSTRUMENT to perform calibration at the 9900 via EasyCal or manual calibration. (See pH Calibration procedures in the Appendix.) Default = AT INSTRUMENT
<code>NO</code> <code>HOLD OUTPUTS</code>	YES prevents relays from activating while making adjustments, and relays in PULSE mode will suspend pulsing. 4 to 20 mA output is held until the user exits the CAL menu. Select YES/NO. Default = NO
<code>EASY CAL</code> →	(CAL AT INSTRUMENT only) Press ► to start the EasyCal process. You will be prompted to enter your password. (See pH EasyCal procedure in the Appendix).
<code>SET</code> <code>PH STANDARD</code>	(CAL AT INSTRUMENT only) Applies a linear offset to the pH measurement. The ideal value is the average pH of your application. (A sample of your application at process temperature is recommended) (See pH Calibration procedures in the Appendix) Shows error message if offset too high.
<code>SET</code> <code>PH SLOPE</code>	(CAL AT INSTRUMENT only) Applies a slope to the pH measurement. The slope value and the standard value must be at least 2 pH units apart. The ideal values are the minimum and maximum values of your process. (See pH Calibration procedures in the Appendix.) Shows error message if slope is too low or high.
<code>SET</code> <code>TEMPERATURE</code>	(CAL AT INSTRUMENT only) Applies a linear offset to the temperature measurement. The ideal value is the average temperature of your application. "SAVING" will appear if offset is acceptable, "ERR TOO LARGE TO CALIBRATE" if offset is outside of range.
<code>RESET PH CAL</code>	(CAL AT INSTRUMENT only) Press ► to reset pH Calibration to factory default.
<code>RESET TEMPCAL</code>	(CAL AT INSTRUMENT only) Press ► to reset temperature calibration to factory default.
<code>LAST</code> <code>CAL</code> <code>MM-DD-YYYY II</code>	Enter date of calibration (mm-dd-yyyy) and initials of calibrator (ii).

INPUT Menu

<code>NAME</code> <code>MEAS TYPE PH</code>	Enter string up to 13 characters (optional). Default = MEAS TYPE PH
<code>°C</code> <code>TEMP UNITS</code>	Select °F or °C Default = °C
<code>AVERAGE</code> OFF	Dampens display, output and relay response rates. Select Low, Med, High, OFF. Default = OFF (see discussion in Appendix). NOTE: Signet strongly recommends leaving averaging OFF for pH and Pressure measurements
<code>MI_n</code> <code>60</code> <code>IMPEDANCE</code> <code>UPDATE TIME</code>	(2751 preamp only, 9900 Generation IV or greater) Set AUTOMATED GLASS IMPEDANCE update time from 0 to 1440 minutes. Setting update time to 0 turns off automatic glass impedance updates. Default = 60 minutes
<code>MΩ_{hm}</code> <code>3</code> <code>BROKEN GLASS</code>	(2751 preamp only, 9900 Generation V or greater) Enter the impedance value for broken glass, 0 = OFF, Default = 3 MΩ
<code>x</code> <code>OFF</code> <code>HI IMPEDANCE</code> <code>WARNING</code>	(2751 preamp with memory chip enabled sensors only, 9900 Generation IV or greater) High Impedance Warning is activated when the AUTOMATED GLASS IMPEDANCE measurement is greater than the Factory Glass Impedance by selected multiplier. Select multiplier of 2, 3, 4, 5, or OFF. Default = OFF NOTE: Factory Glass Impedance can be found under the VIEW mode by pressing ► on SENSOR DATA.



This is the normal display and does not time out.



ORP Setup Checklist

1. Make sure ORP sensor type is selected (see System Setup Menu, page 24).
2. If LOOP is used, set the minimum and maximum 4 to 20 mA setpoints.
3. Set Averaging.
4. Perform calibration or set Standard (and Slope if desired).
5. Set Last Cal Date and initials.
6. If desired, set up relay functions for your own application.

VIEW Mode Menu

RAW ----- mV	Displays the millivolt input from the electrode. Use this display to determine the relative condition of your electrode during periodic calibration.
SENSOR DATA->	(2751 preamp with memory chip enabled sensors only, 9900 Generation IV or greater) Press ► to access sensor data stored on sensor memory chip. NOTE: Pressing ▲+▼, or changing to a sensor without a memory chip, while viewing SENSOR DATA, will return the 9900 to the top VIEW mode display (current ORP measurement).
S/n 6 140 122 1234	(2751 preamp with memory chip enabled sensors only, 9900 Generation IV or greater) Sub-menu of stored sensor data, accessed by pressing ► on the above SENSOR DATA menu. SENSOR DATA includes: Sensor Serial Number (S/n), Sensor Model Number (MOD), ORP Slope, ORP Offset, Total Usage Time (HRS), Minimum ORP value measured (MIN mV), Maximum ORP value measured (MAX mV)
LOOP 450 mA	Displays the 4 to 20 mA LOOP output
RLYS 1 2 3 OFF OFF OFF	Bottom line shows one of three states (OFF, ON, PLS) for each of the three relays. Displays remaining time for CYC LOW or CYC HIGH mode. The relay(s) will remain ON while counting down. NOTE: (Reset the Timer) In the RELAY menu, select TEST RELAY function. The timer will reset to 0 if the condition no longer exists when the TEST is performed. The timer will restart if the condition still exists.

CAL Menu

CAL
AT INSTRUMENT

Select AT SENSOR to perform calibration using the Signet 2751 sensor electronics. Select AT INSTRUMENT to perform calibration at the 9900 via EasyCal or manual calibration. (See ORP Calibration procedures in the Appendix.) Default = AT INSTRUMENT

NO
HOLD OUTPUTS

YES prevents relays from activating while making adjustments, and relays in PULSE mode will suspend pulsing. Output is held until the user exits the CAL menu. Select YES/NO. Default = NO

EASY CAL →

(CAL AT INSTRUMENT only) Press ► to start the EasyCal process. You will be prompted to enter your password. (See ORP EasyCal procedure in the Appendix).

SET
ORP STANDARD

(CAL AT INSTRUMENT only) Applies a linear offset to the ORP measurement. For single point calibrations, assign the average value of your process to ORP STANDARD. For two-point calibrations, assign the min or max value of your process to ORP STANDARD. (See ORP Calibration procedures in the Appendix).

SET
ORP SLOPE

(CAL AT INSTRUMENT only) Applies a slope to the ORP measurement. The ORP SLOPE is used for two-point calibration along with the ORP STANDARD. If you applied the min value of your process to the ORP STANDARD, then apply the max value to the ORP SLOPE. Else, apply the min value to the ORP SLOPE. The slope value and the standard value must be at least 30 mV apart. (See ORP Calibration procedures in the Appendix)

RESET ORP CAL

(CAL AT INSTRUMENT only) Resets calibration to factory settings. After pressing ►, select YES/NO.

LAST
CAL
MM-DD-YYYY II

Enter date of calibration (mm-dd-yyyy) and initials of calibrator (ii).

INPUT Menu

NAME
ORP

Enter string up to 13 characters (optional). Default = ORP

AVERAGE OFF

Dampens display, output and relay response rates. Select Low, Med, High, OFF. (See discussion in Appendix.) Default = OFF



This is the normal display and does not time out.



Cond/Res Setup Checklist

1. Make sure COND/RES sensor type is selected (see System Setup Menu, page 24).
2. Set Cell Constant.
3. Set the Temperature Units (°C or °F).
4. Set Conductivity units.
5. If LOOP is used, set the minimum and maximum 4 to 20 mA setpoints.
6. Set Temperature Compensation.
7. Set Last Cal Date and initials.
8. Select source for Open Collector and Relay output (COND or TEMP).
9. If desired, setup relay functions for your own application.







VIEW Mode Menu

TEMP	----	mV	Displays temperature at the sensor.
LOOP	720	mA	Displays the 4 to 20 mA LOOP output.
RLYS	1 2 3	OFF OFF OFF	Bottom line shows one of three states (OFF, ON, PLS) for each of the three relays. Displays remaining time for CYC LOW or CYC HIGH mode. The relay(s) will remain ON while counting down. NOTE: (Reset the Timer) In the RELAY menu, select TEST RELAY function. The timer will reset to 0 if the condition no longer exists when the TEST is performed. The timer will restart if the condition still exists.

CAL Menu

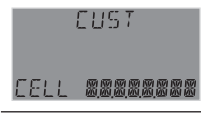
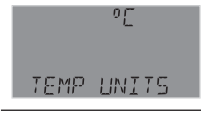
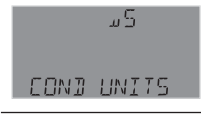
NO	HOLD OUTPUTS	YES prevents relays from activating while making adjustments, and relays in PULSE mode will suspend pulsing. Output is held until the user exits the CAL menu. Select YES/NO. Default = NO.
AUTO CAL		Shows real-time value and selected standard. "PLACE SENSOR IN STANDARD". Unit waits until reading is stable; if bad cal, returns "ERROR, CANNOT DETERMINE STANDARD". Refer to buffer values and AUTO CAL Procedure in the Appendix.
MANUAL CAL		Shows "CONDUCTIVITY" on bottom line; when user presses any button the live value is frozen and the user edits that value. If bad cal, returns "ERR TOO LARGE TO CALIBRATE". See Manual Cal procedure in Appendix.
SET	TEMPERATURE	Shows "TEMPERATURE" on bottom line; when user presses any button the live value is frozen and the user edits that value. If bad cal, returns "ERR TOO LARGE TO CALIBRATE".
RESET CONDCAL		Resets Conductivity calibration. After pressing ►, select YES/NO.
RESET TEMPCAL		Resets Temperature calibration. After pressing ►, select YES/NO.
LAST CAL	MM-DD-YYYY II	Enter date of calibration (mm-dd-yyyy) and initials of calibrator (II).

INPUT Menu

	Enter string up to 13 characters (optional). Default = COND/RES
	Enter cell constant of sensor. Select 20.0, 10.0, 1.0, 0.1, 0.01, or CUSTOM. Default = 1.0 (See NOTE below)
	Enter the precise cell constant from the certificate provided with your sensor, or from the information label on the sensor. All cell constants must be larger than 0.001. Shown if CELL CONSTANT = CUSTOM. (See NOTE below) Important: Do not set cell constant to zero.
	Select °C, °F Default = °C
	Select μS, mS, PPM, PPB, KOhm, or MOhm. Default = μS. NOTE: In USP Relay Mode, TEMP COMP must be set to NONE and Unit Of Measure must be set to μS.
	If the COND UNITS selection is PPM or PPB, set the ratio of Total Dissolved Solids to μS. Default = 0.50
	Dampens display, output and relay response rates. Select Low, Med, High, or OFF. (See discussion in Appendix) Default = OFF
	Select temperature compensation (NONE, LINEAR, PURE H2O). Default = LINEAR. NOTE: In USP Relay Mode in Conductivity, Relay Source must be set to COND, TEMP COMP must be set to NONE and Unit Of Measure must be set to μS.
	For LINEAR or PURE H2O temperature compensation, select a % per °C slope. Maximum slope setting is 9.99 % per °C. Default = 2.0 (If Temperature Compensation setting is NONE, this item will not be displayed)

Factory-Set Span:

- 0.01 cell (2819, 2839) 0 to 100 μS
- 0.10 cell (2820, 2840) 0 to 1000 μS
- 1.0 cell (2821, 2841) 0 to 10,000 μS
- 10.0 cell (2822, 2842) 0 to 200,000 μS
- 20.0 cell (2823) 0 to 400,000 μS

NOTE: If using a 2850 Conductivity/Resistivity Sensor Electronics in conjunction with your 9900, the 2850 must be set for the custom cell constant or the actual probe cell constant and the 9900 set for a 1.0 cell constant.

Important: Do not set cell constant to 0, zero.



This is the normal display and does not time out.



PRESSURE Setup Checklist

1. Make sure PRESSURE sensor type is selected (see System Setup Menu, page 24).
2. If LOOP is used, set the minimum and maximum 4 to 20 mA setpoints.
3. Set Units of Measurement (PSI, BAR, KPa).
4. Set Last Cal Date and initials.
5. If desired, set up relay functions for your own application.

VIEW Mode Menu

LOOP 720 mA Displays the 4 to 20 mA LOOP output



Bottom line shows one of three states (OFF, ON, PLS) for each of the three relays. Displays remaining time for CYC LOW or CYC HIGH mode. The relay(s) will remain ON while counting down.
NOTE: (Reset the Timer) In the RELAY menu, select TEST RELAY function. The timer will reset to 0 if the condition no longer exists when the TEST is performed. The timer will restart if the condition still exists.

CAL Menu



ON prevents relays from activating while making adjustments, and relays in PULSE mode will suspend pulsing. Output is held until the user exits the CAL menu. Select OFF/ON.
 Default = OFF

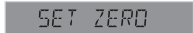

With process pressure at zero, set zero point for measurement.



Calibrate pressure reading to external reference. Provides a maximum 5 psi offset.



Resets calibration to factory default. After pressing ►, select YES/NO.



Enter date of calibration (mm-dd-yyyy) and initials of calibrator (II)

INPUT Menu



Enter string up to 13 characters (optional).
 Default = PRESSURE



Enter units of pressure measurement. Select PSI, BAR, or KPa.
 Default = PSI



Dampens display, output and relay response rates.
 Select: Low, Med, High, OFF (see discussion in Appendix.)
 Default = OFF. Signet strongly recommends leaving averaging OFF for pH and pressure measurements (see discussion in Appendix).



This is the normal display and does not time out.



LEVEL/VOLUME Setup Checklist

1. Make sure LEVEL/VOLUME sensor type is selected (see System Setup Menu, page 24).
2. Select Main Measurement (Level or Volume).
3. Set Units of Measurement for LEVEL display (FT, IN, M, CM).
4. If desired, set Units of Measurement for VOLUME display.
5. Set the minimum and maximum 4 to 20 mA setpoints.
6. Set Specific Gravity.
7. Set Sensor Offset.
8. If VOLUME is used, set Shape.
9. Set Last Cal Date and initials.
10. If desired, set up relay functions for your own application.

VIEW Mode Menu

VOL 00 GAL Displays the Volume value on the bottom line of the screen when LVL is the MAIN MEAS selection in INPUT menu.

LVL 00 FT Displays the Level value on the bottom line of the screen when VOL is the MAIN MEAS selection in INPUT menu.

LOOP 7.20 mA Displays the 4 to 20 mA LOOP output

RLYS 1 2 3
OFF OFF OFF Bottom line shows one of three states (OFF, ON, PLS) for each of the three relays. Displays remaining time for CYC LOW or CYC HIGH mode. The relay(s) will remain ON while counting down.
NOTE: (Reset the Timer) In the RELAY menu, select TEST RELAY function. The timer will reset to 0 if the condition no longer exists when the TEST is performed. The timer will restart if the condition still exists.

CAL Menu

NO
HOLD OUTPUTS ON prevents relays from activating while making adjustments, and relays in PULSE mode will suspend pulsing. Output is held until the user exits the CAL menu. Select OFF/ON.
Default = OFF

LEVEL CAL Shows SET LEVEL on bottom line. When user presses any key, the live value is frozen and the user edits that value. Returns either GOOD CAL or LEVEL OFFSET TOO LARGE.

RESET CAL Resets calibration to factory default. After pressing ►, select YES/NO.

LAST CAL
MM-DD-YYYY II Enter date of calibration (mm-dd-yyyy) and initials of calibrator (ii).

INPUT Menu

<p>NAME LEVEL/VOLUME</p>	<p>Enter 13-character string (optional). Default = LEVEL/VOLUME</p>
<p>LVL MAIN MERS</p>	<p>Select between Level or Volume. Default = LVL</p>
<p>FT LEVEL UNITS</p>	<p>Select unit of measure for LEVEL display (FT, IN, M, CM). Default = FT</p>
<p>OFF PERCENT LEVEL</p>	<p>ON = Measurement will be displayed as a percentage of full scale. OFF = Measurement will be displayed in unit of measure selected in previous setting. Default = OFF</p>
<p>FT 1000 LEVEL AT 100%</p>	<p>If PERCENT LEVEL = ON, set the desired full scale (100%) value in units of measure. Default = 10.00</p>
<p>GAL VOLUME UNITS</p>	<p>Select unit of measure for VOLUME display (GAL, LIT, Lb, KG, FT³, in³, M³, cm³). Default = GAL</p>
<p>OFF PERCENT VOL</p>	<p>Select ON = Measurement will be displayed as a percentage of full scale. OFF = Measurement will be displayed in unit of measure selected in previous setting. Default = OFF</p>
<p>GAL 100.00 VOL AT 100%</p>	<p>If PERCENT VOLUME = ON, set the full scale value (100%) in units of measure. Default = 100.00</p>
<p>10000 SPEC GRAVITY</p>	<p>Enter the specific gravity of the fluid at normal operating temperature. This setting is required only if the level measurement is made by a pressure sensor or if kg or lb volume units are selected. Default = 1.0000 (water)</p>
<p>FT 00000 SENS OFFSET</p>	<p>Enter the distance from sensor location to the Zero reference point in the vessel (see discussion in Appendix). Displayed in units of measure chosen in LEVEL UNITS. Default = 0</p>
<p>AVERAGE OFF</p>	<p>Dampens display, output and relay response rates. Select Low, Med, High, OFF (see discussion in Appendix). Default = OFF</p>
<p>SHAPE VERT CYLINDER</p>	<p>Select the shape of the vessel where the level sensor is located. VERT CYLINDER, HORIZ CYLINDER, RECTANGLE, or CUSTOM. (To define a custom tank shape, see Appendix page 52, Defining a Custom Tank.) Default = VERT CYLINDER</p>
<p>FT 20000 TANK DIAMETER</p>	<p>If VERT CYLINDER or HORIZ CYLINDER is selected, enter the diameter of the cylinder. Displayed in units of measure chosen in LEVEL UNITS. Default = 2.0000</p>



This is the normal display and does not time out.



TEMPERATURE Setup Checklist

1. Make sure TEMPERATURE sensor type is selected (see System Setup Menu, page 24).
2. If LOOP is used, set the minimum and maximum 4 to 20 mA setpoints.
3. Set Units of Measurement (°C or °F).
4. Set Last Cal Date and initials.
5. If desired, set up relay functions for your own application.

VIEW Mode Menu

LOOP 7.20 mA Displays the 4 to 20 mA LOOP output



Bottom line shows one of three states (OFF, ON, PLS) for each of the three relays. Displays remaining time for CYC LOW or CYC HIGH mode. The relay(s) will remain ON while counting down.
NOTE: (Reset the Timer) In the RELAY menu, select TEST RELAY function. The timer will reset to 0 if the condition no longer exists when the TEST is performed. The timer will restart if the condition still exists.

CAL Menu



ON prevents relays from activating while making adjustments, and relays in PULSE mode will suspend pulsing. Output is held until the user exits the CAL menu. Select OFF/ON.
 Default = OFF



Provides a maximum 20 °C offset to match to a known standard (external reference).



Resets Temperature Calibration to factory settings. After pressing ►, select YES/NO.



Enter date of calibration (mm-dd-yyyy) and initials of calibrator (ii).

INPUT Menu



Enter string up to 13 characters (optional).
 Default = "TEMPERATURE"



Select °C or °F
 Default = °C

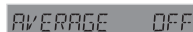

Dampens display, output and relay response rates.
 Select Low, Med, High, OFF. (See discussion in Appendix.)
 Default = OFF



This is the normal display and does not time out.



4 to 20 mA Setup Checklist

1. Make sure 4-20 mA INPUT sensor type is selected (see System Setup Menu, page 24).
2. Set 4 mA value (refer to your 3rd-party sensor manual).
3. Set 20 mA value (refer to your 3rd-party sensor manual).
4. If LOOP is used, set the minimum and maximum 4 to 20 mA setpoints.
5. Set Last Cal Date and initials.
6. If desired, set up relay functions for your own application.

VIEW Mode Menu

LOOP 720 mA Displays the 4 to 20 mA LOOP output

INPUT --- --mA Diagnostic display showing raw input from 4 to 20 mA sensor.



Bottom line shows one of three states (OFF, ON, PLS) for each of the three relays. Displays remaining time for CYC LOW or CYC HIGH mode. The relay(s) will remain ON while counting down.

NOTE: (Reset the Timer) In the RELAY menu, select TEST RELAY function. The timer will reset to 0 if the condition no longer exists when the TEST is performed. The timer will restart if the condition still exists.

CAL Menu

NO
HOLD OUTPUTS ON prevents relays from activating while making adjustments, and relays in PULSE mode will suspend pulsing. Output is held until the user exits the CAL menu. Select OFF/ON. Default = OFF

SET STANDARD Applies a linear offset to the measurement. For single point calibrations, assign the average value of your process to STANDARD. For two-point calibrations, assign the min or max value of your process to STANDARD.





SET SLOPE Applies a slope to the measurement. The SLOPE is used for two-point calibrations along with the STANDARD above. If you assigned the min value of your process to the STANDARD, then assign the max value to the SLOPE. Else, assign the min value to the SLOPE. The slope and standard values must be at least 0.1 units apart.

RESET CAL Resets Standard and Slope calibration to factory settings. After pressing ►, select YES/NO.



Enter date of calibration (mm-dd-yyyy) and initials of calibrator (ii).

INPUT Menu

	Enter string up to 13 characters (optional). Default = 4-20 mA INPUT
	Enter up to 4 characters describing unit of measure. Default = UNIT
	Measurement value of your sensor when its output is 4.00 mA.
	Measurement value of your sensor when its output is 20.00 mA.
	Dampens display, output and relay response rates. Select Low, Med, High, OFF. (See discussion in Appendix.) Default = OFF



This is the normal display and does not time out.



SALINITY Setup Checklist

1. Make sure SALINITY sensor type is selected (see System Setup Menu, page 25).
2. Set Cell Constant.
3. Set the Temperature Units (°C or °F).
4. If LOOP is used, set the minimum and maximum 4 to 20 mA setpoints.
5. Set Last Cal Date and initials.
6. Select source for Open Collector and Relay output (SAL or TEMP).
7. If desired, set up relay functions for your own application.

VIEW Mode Menu

TEMP 00000 °C Displays temperature at the sensor.

LOOP 720 mA Displays the 4 to 20 mA LOOP output.

COND 00000 mS Displays the equivalent conductivity value in milliSiemens.

RLYS
1 2 3
OFF OFF OFF

Bottom line shows one of three states (OFF, ON, PLS) for each of the three relays. Displays remaining time for CYC LOW or CYC HIGH mode. The relay(s) will remain ON while counting down.

NOTE: (Reset the Timer) In the RELAY menu, select TEST RELAY function. The timer will reset to 0 if the condition no longer exists when the TEST is performed.

The timer will restart if the condition still exists.

CAL Menu

NO
HOLD OUTPUTS YES prevents relays from activating while making adjustments, and relays in PULSE mode will suspend pulsing. Output is held until the user exits the CAL menu. Select YES/NO.
Default = NO

SET
SALINITY Manually set salinity value to match to a known standard (external reference).

SET
TEMPERATURE Provides a maximum 20 °C offset to match to a known standard (external reference).

RESET SAL CAL Resets Salinity calibration to factory settings. After pressing ►, select YES/NO.

RESET TEMP CAL Resets Temperature calibration to factory settings. After pressing ►, select YES/NO.

LAST
CAL
MM-DD-YYYY II Enter date of calibration (mm-dd-yyyy) and initials of calibrator (II).

INPUT Menu

NAME SALINITY	Enter string up to 13 characters (optional). Default = SALINITY
200 CELL CONSTANT	Enter cell constant of sensor. Select 20.0, 10.0, 1.0 or CUSTOM. Default = 20
CUST CELL 00000000	Enter the precise cell constant from the certificate provided with your sensor, or from the information label on the sensor. All cell constant must be larger than 0.001. Shown if CELL CONSTANT = CUSTOM. Important: Do not set cell constant to 0, zero.
°C TEMP UNITS	Select °C or °F Default = °C
AVERAGE OFF	Dampens display, output and relay response rates. Select Low, Med, High, OFF. (See discussion in Appendix.) Default = OFF
TEMP COMP LINEAR	Select temperature compensation (NONE, LINEAR). Default = LINEAR
% 200 ADJ TEMP COMP	For LINEAR temperature compensation, select a % per °C slope. Maximum slope setting is 9.99 % per °C. (If Temperature Compensation setting is NONE, this item will not be displayed.)

Dissolved Oxygen



This is the normal display and does not time out.



DISSOLVED O2 Setup Checklist (3-2610-51)

2610 wiring on page 15.

1. Make sure DISSOLVED O2 sensor type is selected (see System Setup Menu, page 24).
2. Set Units of Measurement (PPM, %SAT, TOR).
3. Set the Temperature Units (°C or °F).
4. Set Salinity reference value.
5. Set Barometric reference value.
6. If LOOP is used, set the minimum and maximum 4 to 20 mA setpoints.
7. Select source for Open Collector and Relay output (PPM or TEMP).
8. If desired, set up relay functions for your own application.

VIEW Mode Menu

TEMP -----°C Displays temperature at the sensor.

LOOP 7.20 mA Displays the 4 to 20 mA LOOP output.

EXP

MM-YYYY Displays Cap Expiration Date MM-YYYY. If sensor cap is missing, ----- will be displayed.

RLYS
1 2 3
OFF OFF OFF
Bottom line shows one of three states (OFF, ON, PLS) for each of the three relays. Displays remaining time for CYC LOW or CYC HIGH mode. The relay(s) will remain ON while counting down.
NOTE: (Reset the Timer) In the RELAY menu, select TEST RELAY function. The timer will reset to 0 if the condition no longer exists when the TEST is performed.
The timer will restart if the condition still exists.

CAL Menu

NO
HOLD OUTPUTS YES prevents relays from activating while making adjustments, and relays in PULSE mode will suspend pulsing. Output is held until the user exits the CAL menu. Select YES/NO.
Default = NO.

SET
100% SOLUTION Allows user to initiate the optional calibration process.
NOTE: Dissolved Oxygen sensors are calibrated at the factory and do not require regular calibration. Press ► to begin the calibration process (password required). User will be prompted to place sensor in 100% Solution standard. Press ENTER to save value and establish a calibration point.







SET
0% SOLUTION Allows user to establish an optional second calibration point.
NOTE: Dissolved Oxygen sensors are calibrated at the factory and do not require regular calibration. Press ► to begin the calibration process. User will be prompted to place sensor in 0% Solution standard. Press ENTER to save value and establish an optional second calibration point.
This option is only available immediately after a successful 100% Solution calibration.

RESET DO CAL Resets Dissolved Oxygen calibration to factory settings. After pressing ►, select YES/NO.

LAST
CAL
MM-DD-YYYY II Enter date of calibration (mm-dd-yyyy) and initials of calibrator (II).

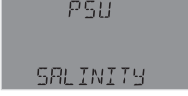
Dissolved Oxygen

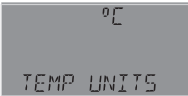
INPUT Menu

	Enter string up to 13 characters (optional). Default = DISSOLVED O2
	Set the units of measurement: PPM = DO in mg/L; %SAT = DO % saturation; TOR = Oxygen partial pressure. Default = PPM
	Manually set Salinity value to match application Salinity (0 - 42 PSU). Units in Practical Salinity Unit (PSU). Fresh water = 0.00 PSU. Default = 0.00
	Manually set Barometric value to match application altitude above or below sea level (506.62 - 1114.7 mBAR). Default = 1013.2 (sea level)
	Select °C or °F. Default = °C
	Dampens display, output and relay response rates. Select Low, Med, High, OFF. (See discussion in Appendix.) Default = OFF

Troubleshooting

Condition	Possible Causes	Suggested Solution
Wrong Sensor	Incorrect sensor installed	Connect correct sensor
	Sensor Type set incorrectly in 9900	Set correct sensor TYPE in INPUT menu (see page 25)
Wrong Code	Wrong password entered	Enter correct password (see page 26)
K-Factor Out Of Range	K-Factors cannot be set to 0	Enter K-Factor from 0.001 to 99999
Backlight inoperative	9900 operating on loop power	Connect 9900 to 10.8 to 35.2 VDC power
	Backlight turned OFF (NOTE: Backlight can turn off automatically in AUTO mode)	Set BACKLIGHT to LOW, HIGH or AUTO in OPTION menu
Relays 2 and 3 inoperative	9900 operating on loop power	Connect 9900 to 10.8 to 35.2 VDC power
	Relay Module installed incorrectly	Remove and reseal relay module
	Wrong settings in RELAY menu	Use test relay to verify relay operation then check relay settings
Relay LEDs inoperative	9900 operating in Loop Power	Use DC power. Check relay states in VIEW mode for status.
Open Collector (R1) or Relay (R2 or R3) always on	Hysteresis value too large	Change the hysteresis value
	Defective Relay Module	Replace Relay Module
OVR relay state (Pulse Overrun)	Relay pulse rate exceeds maximum of 300 pulses per minute	Increase volume pulse setting
		Reduce system flow rate
	Pulse width set too wide	Decrease pulse width
	(NOTE: Max pulse rate = 300)	
- - - - -	Flow rate exceeds display capability	Increase Flow units time base
		Change unit of measure
	Conductivity/Salinity Cell constant is incorrect	Conductivity/Salinity, set the Cell Constant to the correct value

Troubleshooting

Condition	Possible Causes	Suggested Solution
Check Sensor (pH/ORP, Conductivity, Salinity)	9900 cannot "talk" to sensor	<ul style="list-style-type: none"> • Check wiring • Install or replace sensor • Check Conductivity electrode wiring
	Missing sensor or bad temperature element	
	Mis-wired Conductivity electrode	
No Sensor (Flow, Cond/Res, Press, Level, Temp, 4-20 mA, Sal, Batch, DO)	9900 cannot "talk" to sensor	<ul style="list-style-type: none"> • Check wiring • Install or replace sensor
Check Preamp	9900 cannot "talk" to the preamp	Check wiring or replace preamp
Warning LED lit	Look for error message	Correct error condition
Missing Cap	Dissolved Oxygen sensor is missing the sensor cap	Reinstall Dissolved Oxygen sensor cap
Replace Cap	Dissolved Oxygen sensor cap has expired	Install new Dissolved Oxygen sensor cap
Broken Glass (2751 Only)	pH sensor glass has been damaged, causing very low impedance.	Visually inspect pH sensor for cracked and/or chipped glass. After inspection or replacement of pH Sensor wait 30 seconds and then manually start a glass impedance measurement, page 33. This will clear the Broken Glass alarm.
Hi Impedance (2751 Only)	The measured pH sensor impedance is above the high impedance level	Visually inspect the pH electrode and clean if necessary
	Electrode could be in air	Ensure electrode is submersed at all times
Check Cal (2751 pH/ORP only)	Slope and/or Offset are out of range (possibly due to memory failure in sensor or preamp)	Perform pH EasyCal (pg. 34 & 56)
		Perform ORP EasyCal (pg. 36 & 58)
		Set pH Slope or Standard (pg. 34 & 57)
		Set ORP Slope or Standard (pg. 36 & 59)
		Reset pH CAL (pg. 34)
		Reset ORP CAL (pg. 36)
Sensor Data Screen missing (2751 Only)	pH/ORP Sensor installed does not have a memory chip. or communication error	<p>Older GF Signet electrodes, such as the 2754, or electrodes with BNC type connectors do not have memory chips. When the 9900 detects a non-memory chip electrode, the Sensor Data display will not be shown.</p> <p>If a memory chip enabled sensor is installed, a communication error between the memory chip and 2751, or 2751 and 9900, may have occurred. To clear the error and restore the Data Screen, you may do one of the following:</p> <ul style="list-style-type: none"> • Disconnect the (S³L) connection between the 9900 and the 2751, wait 5 seconds, reconnect the (S³L) connection between the 9900 and the 2751. • Cycle power to the 9900.

Averaging

■ ■ ■ ■ ■ NO AVERAGING, NO SENSITIVITY

With SENSITIVITY set to a large value and AVERAGING set to OFF (0 seconds), the 9900 responds immediately to every shift in the process. The dashed red line represents the actual output of the sensor in varying conditions.

■■■■■■■■■■ AVERAGING ONLY

With SENSITIVITY still set to a large value and AVERAGING set to MED or HIGH the rate is stabilized, but a sharp change in rate is not represented for 8 to 32 seconds or longer.

■■■■■■■■■■ AVERAGING AND SENSITIVITY

With SENSITIVITY at 50 and AVERAGING set to MED or HIGH, the rate is stabilized, while a sudden shift in flow rate exceeding 50 units of measure will be displayed immediately.

NOTE: The SENSITIVITY function applies only to FLOW. The SENSITIVITY function has no effect if the AVERAGING function is set to OFF. Averaging will not function if the Sensitivity is set to 0 (Zero).

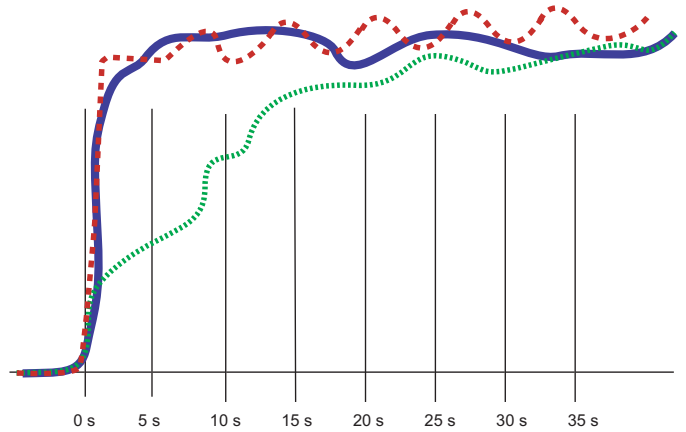

Averaging is different depending on the measurement type. Seconds to 95% of Final Value for Low, Med, and High are:

Sensor Type	Low	Medium	High
Flow	5	25	60
pH	1	2	6
ORP	1	2	6
Cond/Res	2	3	6
Pressure	2	5	15
Level/Volume	2	5	15
Temperature	2	5	15
4 to 20 mA	2	5	15
Salinity	2	3	6

Note: Dissolved Oxygen, 2610-41/51 requires 35 seconds to reach 95% of final value.

Important

With Averaging set to Off the Sensitivity function is disabled. With Sensitivity set to 0 (zero) the Averaging function is disabled.

To set the unit to Averaging with no Sensitivity set Sensitivity to a large value, 99999.

Example: Sensitivity overrides the averaging function. For example with a sensitivity of 150 and a flow of 1000 the averaging will work for any fluctuation in from between 850 to 1150. If the fluctuation was below 850 or above 1150 the reading would immediately jump to the new reading

LOG Current Loop Output

In Conductivity/Resistivity, the logarithmic (LOG) mode can be used when a very large measurement range is required, yet high resolution is needed at the low end (e.g. in a clean-in-place application where a high-resolution conductivity reading is needed at the low end, while a very high conductivity reading is needed when a cleaning cycle is in progress).

Only two parameters need to be set up, the starting or base conductivity value (4 mA SETPNT) and the ending or maximum conductivity value (20 mA SETPNT). The 4 mA setpoint may be larger than the 20 mA point (reverse span).

What equation should be put in the PLC?

$$\text{Conductivity} = 10^n$$

$$n = (\text{mA input} - 4.0) \times \frac{(\text{Log}_{10} 20 \text{ mA setpnt} - \text{Log}_{10} 4 \text{ mA setpnt})}{16 \text{ mA}} + \text{Log}_{10} 4 \text{ mA setpnt}$$

If only fixed thresholds are of required, they can be calculated in mA. Then the mA value can be checked directly.

Inside the 9900 the following equation is used:

$$\text{mA} = (\text{Log}_{10} \text{Conductivity} - \text{Log}_{10} 4 \text{ mA setpnt}) \times \frac{16}{(\text{Log}_{10} 20 \text{ mA setpnt} - \text{Log}_{10} 4 \text{ mA setpnt})} + 4$$

NOTE:

If ADJUST 4 mA or ADJUST 20 mA is used, the mA value can be affected. To prevent any problems the adjust function should only be used to get exactly 4.0 and 20.0 at the PLC. The 9900 is accurate and the adjust functions are only needed to compensate for an offset due to noise or a not-so-accurate PLC input card.

The error value of either 3.6 mA or 22 mA should be tested first before applying the conductivity equation.

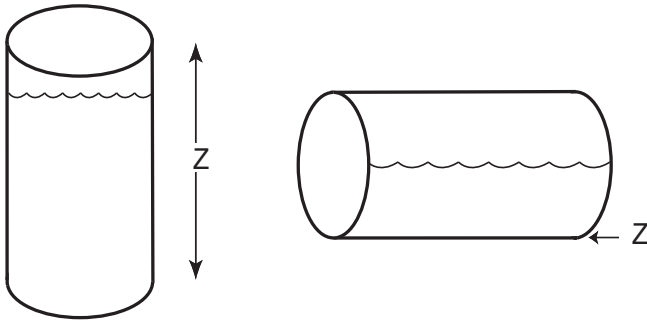

For most vessels, the zero reference point (Z) may be designated as any height in the vessel.

For horizontal cylinders only, the zero reference point MUST be the lowest point in the vessel.

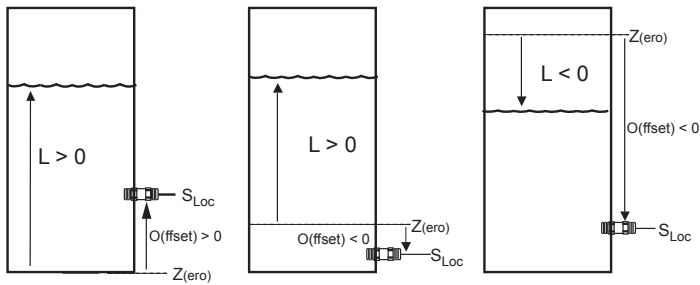

Defining a Custom Tank

1. Determine where the level measurement should start. This is the zero reference point (Z). Review the diagram to help select the best option.
2. Determine where you will mount the sensor. This is S_{LOC}. Consult the Sensor manual for information regarding the best location for the sensor.
3. Measure the distance between Z and S_{LOC}. This is O(ffset).
4. Enter the Offset into the INPUT Mode menu.

Zero reference point (Z):

The point in the vessel where you want the 9900 to display zero (0 ft, 0 gal. etc.).

- If Z is located below the fluid surface, the 9900 will display a positive level measurement.
- If Z is located above the fluid surface, the 9900 will display a negative level measurement.

Sensor Location point (S_{LOC}):

The point on the level sensor where the measurement is taken.

- The pressure sensor measures from the centerline of the diaphragm.

Offset (O):

The distance from Z to S_{LOC}.

- Enter a positive value in the Calibrate menu if the sensor is located above Z.
- Enter a negative value in the Calibrate menu if the sensor is located below Z.
- Enter 0 in the Calibrate menu if the sensor is located at Z.

Level (L):

The distance from Z to surface of fluid (displayed as "Level" by 9900).

Level and Volume Calculation in Custom Shaped Vessels

In the LEVEL/VOLUME menu, if Custom Shape is selected in the INPUT menu, you can define from three to ten Custom Points to establish the relationship of level to volume in the vessel.

- Select Manual Level Measurement mode to edit both level and volume data (dry configuration).
- Select Automatic Level Measurement mode to accept the sensor measurement of the Level, while you assign a volumetric value to each custom point (wet configuration).
- Enter from 3 to 10 custom points to link level and volume values.
- The first custom point must be the lowest fluid level in the vessel. Each successive point must be greater than the preceding point.
- The last point must be equal to or greater than the highest fluid level in the vessel.
- A custom point should be located at all transition points in the vessel shape (for example, at custom point #9, where the shape changes from a cylinder to a cone).
- The more complex sections should be defined with more points.

NOTE: The conical section of the illustration has been defined by custom points 1 through 9.

- Simpler sections require fewer defining points.

NOTE: A cylinder requires only custom points 9 and 10.

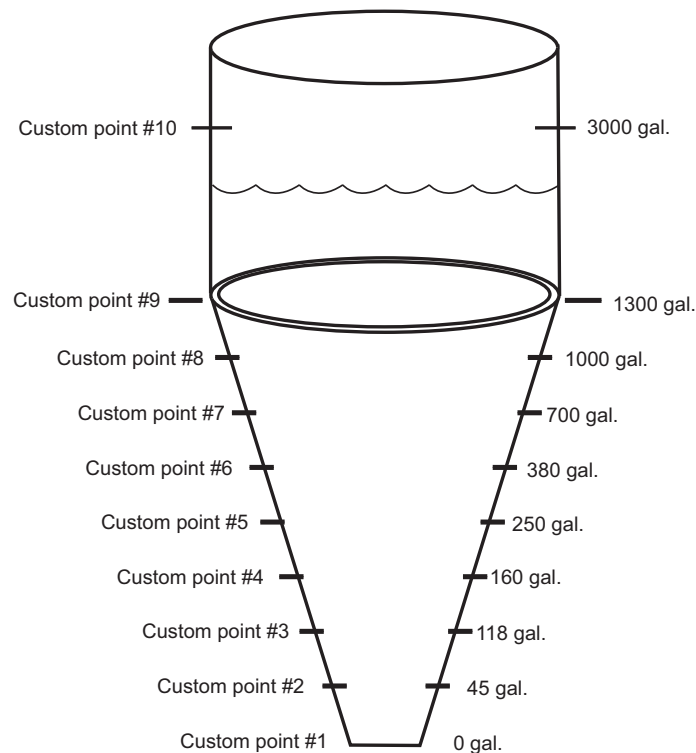

Custom Measurements

In the LEVEL/VOLUME INPUT menu (see page 41), if SHAPE is set to HORIZ CYLINDER, RECTANGLE or CUSTOM, the tank shape can be defined with the following screens:

TANK LENGTH	If Horiz Cylinder or Rectangle shape is selected, enter the length of the vessel in LEVEL UNITS. 0.0000 to 99999.
TANK WIDTH	If Rectangle shape is selected, enter the width of the vessel in LEVEL UNITS. 0.0000 to 99999.
NUM CUST PNTS	If Custom shape is selected, enter the number of measurement points to be used to define the vessel shape (see Level and Volume Calculation in Custom Shaped Vessels discussion). Minimum 3 points, maximum 10 points. A larger number of points improves accuracy.
Auto LEVEL MEAS	Select (AUTO, MAN). Manual allows you to edit both the Level and the corresponding Volume for your custom tank. Automatic allows you to edit the Volume measurement (while displaying an automatically calculated Level value). See example below.
POINT 1 LEVEL	Enter the Level (if MAN measurement is selected) at each custom point in your vessel. If AUTO is selected, indication will read actual tank level in LEVEL UNITS at that point in your tank.
POINT 1 VOL	Set the Volume (if manual measurement is selected) at each custom point in your vessel.
POINT X LEVEL	Where (X) is number of custom points
POINT X VOL	Where (X) is number of custom points

To set AUTO LEVEL MEAS value:

1. Pour a known quantity of fluid into a tank.
2. POINT 1 LEVEL indicates actual tank level.
3. Press ▼ for POINT 1 VOL. Press ► to enter quantity of fluid (in VOLUME UNITS) you poured into the tank in step 1. Press ENTER.
4. Repeat for each point set in NUM CUST PNTS.

For example, in a 25-gallon conical tank set for three custom points:

1. Pour 10 gallons of fluid into the conical tank. POINT 1 LEVEL will indicate actual tank level.
2. In POINT 1 VOL, enter 10.
3. Pour another 10 gallons into the tank. POINT 2 LEVEL will indicate actual tank level.
4. In POINT 2 VOL, enter 10.
5. Pour the final 5 gallons into the tank. POINT 3 LEVEL will indicate actual tank level.
6. In POINT 3 VOL, enter 5.

Technical Reference for Level, Volume, and Mass Measurement

The 9900 can automatically perform level, volume and mass calculations:

- Pressure-to-level
- Mass
- Volume

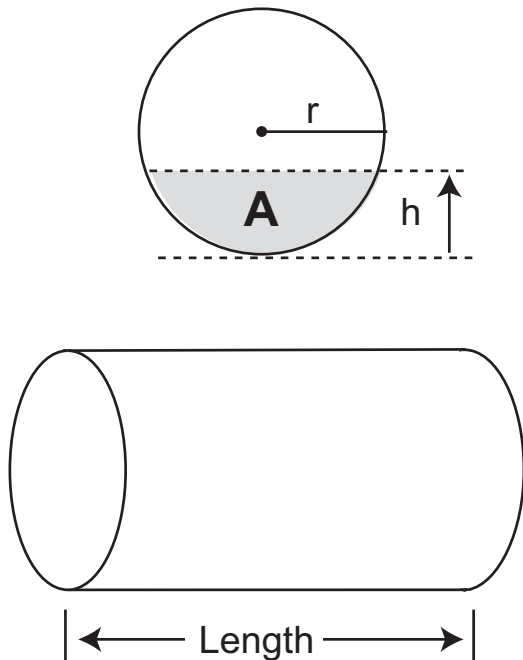

Pressure to level conversion:

$$\text{Level} = P \div (SG \times D)$$

where P = Pressure

SG = Specific Gravity of fluid

D = Density of water

With pressure in psi:

$$\text{Level (meters)} = 0.703069 \times (P/SG)$$

With pressure in bar:

$$\text{Level (meters)} = 1.019715 \times (P/SG)$$

Mass Conversion

$$m = D \times SG \times V$$

where m = mass of fluid

D = density of water = 1000 kg/m³

SG = Specific Gravity of fluid

V = Volume of fluid (m³)

$$m \text{ (kg)} = 1000 \times SG \times V$$

Volume Calculations

Vertical cylinder:

$$V = \pi \times r^2 \times h$$

where r = radius of cylinder

h = height of fluid

Rectangular vessel:

$$V = w \times l \times h$$

where w = width

l = length

h = height

Horizontal cylinder:

$$V = A \times L$$

where A = area of segment

L = length of vessel

$$A = \left[\left(r^2 \times \cos^{-1} \times \frac{r-h}{r} \right) - (r-h) \right] \times \sqrt{2rh - h^2}$$

where r = radius of vessel

h = height of segment

Calibration Procedures - pH

EasyCal Procedure - pH

EasyCal is the fastest and simplest periodic calibration method.
Requires prepared 4, 7 or 10 pH buffers (any two).

To Calibrate:



Place electrode tip in first pH buffer.
pH 4.0 = 177 mV
pH 7.0 = 0 mV
pH 10 = -177 mV



Response:





Allow for stabilization
30 seconds





To Accept:





to accept

Place electrode tip in second pH buffer.

Allow for stabilization
30 seconds

to accept second
buffer calibration



To exit menus and return to VIEW press ▲ and ▼ buttons at the same time.



Display returns to VIEW
Mode in 10 minutes



- This procedure simplifies pH calibration using standard 4.0, 7.0, 10.0 pH buffers only. If these pH buffers are not available, use MANUAL CAL and calibrate the system using the STANDARD and SLOPE settings.
- Set sensor temperature in the CAL Mode before performing EasyCal for new electrode installations.

Theoretical mV values
pH @ 25 °C mV

2	+296
3	+237
4	+177
5	+118
6	+59
7	+0
8	-59
9	-118
10	-177
11	-237
12	-296



NOTE: The solutions can be used for calibrating more than one sensor; however, the solution must remain free of debris and must not be diluted by rinse water from previous calibrations.

Manual Calibration Procedure - pH

Requires prepared buffers. System calibration is possible with two known pH solutions within 0 to 14 pH (buffers of pH 4.01, 7, or 10 are recommended, but use a buffer close to your own process value.)

To Calibrate:

Place electrode tip in pH buffer.

30s
Allow for stabilization 30 seconds to several minutes

To Change Reading:
to accept

To Set Slope:

Place electrode tip in pH buffer two pH units different than standard.

30s
Allow for stabilization 30 seconds to several minutes

To Change Reading:
to accept

To Set Calibration Date:

Display returns to VIEW Mode

Single-point calibration sets STANDARD only; Signet recommends a two-point calibration to set SLOPE in addition to STANDARD.

Quick Manual Calibration Procedures:

1-Point Calibration:

1. Set solution standard.

2-Point Calibration (recommended):

1. Set solution standard.
2. Set solution slope.

EasyCal Procedure - ORP (one-point calibration)

EasyCal is the fastest and simplest periodic calibration method.

Requires a prepared quinhydrone solution or Light's Solution:

Saturate 50 mL of pH 7 (87 mV) or pH 4 (264 mV) buffers with 1/8 g quinhydrone.

Premixed Light's Solution (476 mV) can be used instead of pH buffers with quinhydrone.

To Calibrate:



Place electrode tip in saturated pH 7.0 buffer.
pH 7.0 = 87 mV



Response:



Allow for stabilization
30 seconds

To Accept:



to accept

To exit menus and return to VIEW press ▲ and ▼ buttons at the same time.



Display returns to VIEW Mode in 10 minutes



1. Go to CAL menu.
2. Press ▼ twice to display EASY CAL setting
3. Press ► to begin one-point EasyCal.
4. Place sensor in solution:
 - 87 mV (7 pH + quinhydrone)
 - 264 mV (4 pH + quinhydrone)
 - 476mV (Light's Solution)
5. Press **ENTER**.
6. After 30 seconds, 9900 will recognize current buffer ± 80 mV
7. Press **ENTER** to accept mV value



NOTE: ORP solutions made with quinhydrone are very unstable and may not read properly once exposed to air for a prolonged time. These solutions must be disposed of within an hour.

The solution can be used for calibrating more than one sensor. However, the solution must remain free of debris and must not be diluted by rinse water from previous calibrations.

Acceptable ranges for the readings are ± 80 mV (i.e., 87 ± 80 mV).

Manual Calibration Procedure - ORP

Requires prepared buffers and a prepared quinhydrone solution:
 Saturate 50 mL of pH 4 (264 mV) and 7 (87 mV) buffers with 1/8 g quinhydrone or Light's Solution (476 mV).
 (System calibration is possible with two known ORP solutions, but use a buffer close to your own process value).

To Calibrate:

Place electrode tip in saturated pH 7.0 buffer.
 pH 7.0 = 87 mV

To Change Reading:

to accept

30s
 Allow for stabilization 30 seconds to several minutes

to accept

SAVING

ORP STANDARD

To Set Slope:

Place electrode tip in saturated pH buffer two pH units different than standard.
 pH 4.0 = 264 mV

To Change Reading:

to accept

30s
 Allow for stabilization 30 seconds to several minutes

to accept

SAVING

ORP STANDARD

To Set Calibration Date:

Display returns to VIEW Mode



NOTE: ORP solutions made with quinhydrone are very unstable and may not read properly once exposed to air for a prolonged time. These solutions must be disposed of within an hour.

The solution can be used for calibrating more than one sensor. However, the solution must remain free of debris and must not be diluted by rinse water from previous calibrations.

Acceptable ranges for the readings are ± 80 mV (i.e., 87 ± 80 mV).

Single-point calibration sets STANDARD only; Signet recommends a two-point calibration to set SLOPE in addition to STANDARD.

Quick Manual Calibration Procedures:

1-Point Calibration:

1. Set solution standard.

2-Point Calibration (recommended):

1. Set solution standard.
2. Set solution slope.



Calibration Procedure - Conductivity / Resistivity

AutoCal is the fastest and simplest periodic calibration method.
Requires prepared buffer of a value appropriate to your process.

AutoCal Procedure

AutoCal is a single-point calibration system. During this procedure, if the measured value is within $\pm 10\%$ of any of the test values listed below, the 9900 will automatically recognize the test value and calibrate the output to that value.

NOTE: The first step (Reset) is recommended each time an electrode is replaced, but is NOT necessary upon initial installation or periodic calibration.

NOTE: Ensure that the buffer solution is within $\pm 5\text{ }^{\circ}\text{C}$ of $25\text{ }^{\circ}\text{C}$.

1. Reset the sensor to factory calibration (refer to sensor manual for procedure).
2. On the 9900, select AUTO CAL from the CAL menu. Press ►.
3. Place the electrode/sensor assembly into the conductivity test solution appropriate to your operating range. Shake the electrode to dislodge any air bubbles visible on the surface of the electrode.
4. Allow at least 2 minutes for the electrode response to stabilize.
5. When the display stabilizes, press ENTER.
6. If calibration is successful, 9900 will display "SAVING". If error is too large, "OUT OF RANGE USE MANUAL CALIBRATION" will display.

Calibration is complete. Return the system to service.

Manual Cal Procedure

NOTE: The first step (Reset) is recommended each time an electrode is replaced, but is NOT necessary upon initial installation or periodic calibration.

NOTE: Ensure that the buffer solution is within $\pm 5\text{ }^{\circ}\text{C}$ of $25\text{ }^{\circ}\text{C}$.

1. Reset the sensor to factory calibration (refer to sensor manual for procedure).
2. On the 9900, select MANUAL CAL from the CAL menu. Press ►.
3. Place the electrode/sensor assembly into the conductivity test solution appropriate to your operating range. Shake the electrode to dislodge any air bubbles visible on the surface of the electrode.
4. Allow at least 2 minutes for the electrode response to stabilize.
5. When the display stabilizes, enter the value of the buffer solution using the ▼, ▲ and ► buttons.
6. Press ENTER.
7. 9900 will display "SAVING". If error is too large, "ERR TOO LARGE TO CALIBRATE" will display.

Calibration is complete. Return the system to service.

Conductivity units are displayed as selected in the CALIBRATE menu. Resistivity displayed when K Ω or M Ω ranges are selected.

Available buffer values are:

- 10
- 100
- 146.93
- 200
- 500
- 1000
- 1408.8
- 5000
- 10,000
- 12856
- 50,000
- 100,000

(all values in μS)

Calibration Procedure - Flow

Select RATE CALIBRATION to match the dynamic flow rate to an external reference. Entering a rate will modify the existing K-Factor.

Select VOLUME CALIBRATION if the flow rate can be determined by filling a vessel of known volume. The 9900 will count the number of pulses generated as the known volume of fluid passes through the sensor, and then use the information to calculate a new K-Factor.

Rate Calibration Procedure

1. Use ▲, ▼ and ► to set the flow rate in the flashing display to match the reference meter. Press ENTER when completed.
2. The 9900 displays the newly calculated K-Factor for your reference. (If the calculated K-Factor is less than 0.0001 or greater than 999999 (out of range at either extreme), the 9900 displays "ERROR NEW KF OUT OF RANGE" and returns to RATE CAL. If flow is too low to accurately calibrate, the 9900 displays "ERROR FLOW RATE TOO LOW" and returns to RATE CAL.
3. Press ENTER to accept the new K-Factor (9900 displays "SAVING") or press ▲+▼ keys simultaneously to escape without saving and return to Enter Volume.
NOTE: You may enter your own calculated K-Factor in the INPUT menu.

Volume Calibration Procedure

1. Press ENTER to start the volumetric calibration period. The 9900 starts counting pulses from the flow sensor.
2. Press ENTER to stop the volumetric calibration period. The 9900 stops counting pulses from the flow sensor.
3. Enter the volume of fluid known to have flowed past the sensor during the volumetric calibration period. This will modify the existing Flow K-Factor.
4. The 9900 displays the newly calculated K-Factor for your reference. (If the calculated K-Factor is less than 0.0001 or greater than 999999 (out of range at either extreme), the 9900 displays "ERROR VOLUME TOO HIGH" (or LOW) and returns to VOLUME CAL.)
5. Press ENTER to accept the new K-Factor (9900 displays "SAVING") or press ▲+▼ keys simultaneously to escape without saving and return to Enter Volume.
NOTE: You may enter your own calculated K-Factor in the INPUT menu.

GPM
0.0000
SET FLOW

KF 600000

START (ENTER)

Run
STOP (ENTER)

G
0.0000
ENTER VOLUME

KF 600000

Calibration Error Messages

Message	Cause	Solution
Out Of Range Use Manual Calibration	(Cond/Res) Error > 10% in AutoCal	Use manual calibration method
	(pH) Buffer not found; Error > ±1.5 pH units	Use 4, 7, 10 pH buffers (with quinhydrone for ORP calibration)
	(ORP) No quinhydrone in buffer Error greater than ±80 mV	Clean sensor and retry EasyCal Use manual calibration method
Err Too Large To Calibrate	(Cond/Res) Manual cal when error > 100%	Inspect sensor and wiring for damage Clean sensor
	(pH) Offset > 1.3 pH units; Slope error > 100%	Check reference Clean sensor Replace sensor
	(Press) Slope must be < ±50% or offset must be < 2.75 PSI or equivalent.	
	(Sal) Slope error > 1000%	
Error Volume Too Low	User-entered volume too small to calibrate	Correct volume entry Use longer calibration period
Error New KF Out Of Range	The calculated K-Factor too low or high	Verify volume or rate entered Verify flow is present
Error Flow Rate Too Low	(Rate Cal) Flow too low to accurately calibrate	Increase flow
Cal Error Out Of Range	(4 to 20 mA) Slope error > 1000%	Check input at 4 mA and 20 mA settings
	(Temp) Offset must be < ±20 °C or equivalent	Check sensor range Check reference Replace sensor
Slope Too Close To Standard	(4 to 20 mA) Difference in calibration values must be > 0.1 units	Check sensor Use fresh buffer Use two different buffer values Clean sensor
	(pH) Difference in calibration values must be > 2 pH units	
	(ORP) Difference in calibration values must be > 30 mV	
Standard Too Close To Slope	(4 to 20 mA) Difference in calibration values must be > 0.1 units	Clean sensor Use fresh 4, 7, 10 pH buffers Use two different buffer values
	(pH) Difference in calibration values must be > 2 pH units	
	(ORP) Difference in calibration values must be > 30 mV	
Level Offset Too Large	Offset must be < 1.0 meter	Decrease offset Replace sensor
Pressure Too High	Pressure must be lower than 2.5 PSI or equivalent to do zero cal	Decrease pressure
Pressure Too Close To Zero	Pressure must be higher than 3 PSI or equivalent to do slope calibration	Increase pressure Check reference
Check Cal (2751 pH/ORP only)	Slope and/or Offset are out of range (possibly due to memory failure in sensor or preamp)	Perform pH EasyCal (pg. 34 & 56)
		Perform ORP EasyCal (pg. 36 & 58)
		Set pH Slope or Standard (pg. 34 & 57)
		Set ORP Slope or Standard (pg. 36 & 59)
		Reset pH CAL (pg. 34)
		Reset ORP CAL (pg. 36)

Important: Do not set the source to Temperature for the USP relay.
 USP (United States Pharmacopoeia) has defined a set of conductivity values (limits) to be used for pharmaceutical water. The standard requires that conductivity measurement without temperature compensation be used for these applications. The limits vary according to the temperature of the sample. The 9900 has the USP limits stored in memory. It will automatically determine the proper USP limit based on the measured temperature.

Using the USP function

USP setpoints are defined as a percentage below the USP limit, so a USP alarm is always a HIGH alarm. The 9900 can be set to warn you if the conductivity approaches within a set percentage of the USP limit.

The following settings and conditions are required for a USP relay function:

1. In the RELAY menu:
 - RELAY MODE must be set to **USP**.
2. In the INPUT menu:
 - COND UNITS must be set to **µS**.
 - TEMP COMP must be set to **None**.

Example:

- The water temperature is 19 °C, so the USP limit is 1.0 µS.
- The USP PERCNT is set to 40%.
- The relay will be activated when the conductivity value reaches 40% below the 1.0 USP limit, or 0.6 µS.
- If the water temperature drifts to more than 20 °C, the 9900 will automatically adjust the USP limit to 1.1. The relay will now be activated when the conductivity value reaches 40% below 1.1 µS (0.66 µS).

Temperature Range (°C)	USP limit (µS)
0 to < 5	0.6
5 to < 10	0.8
10 to < 15	0.9
15 to < 20	1.0
20 to < 25	1.1
25 to < 30	1.3
30 to < 35	1.4
35 to < 40	1.5
40 to < 45	1.7
45 to < 50	1.8
50 to < 55	1.9
55 to < 60	2.1
60 to < 65	2.2
65 to < 70	2.4
70 to < 75	2.5
75 to < 80	2.7
80 to < 85	2.7
85 to < 90	2.7
90 to < 95	2.7
95 to < 100	2.9
100 to < 105	3.1

How HART® Works

The HART® (**H**ighway **A**ddressable **R**emote **T**ransducer) Protocol uses Frequency Shift Keying (FSK) to superimpose digital signals on top of the analog 4 to 20 mA current loop. This allows two-way digital communication to occur and allows additional information beyond the normal process data to be communicated to the 9900. This digital signal can contain data such as device status, diagnostics, etc.

The HART protocol provides two simultaneous communication channels: a 4 to 20 mA analog signal and a digital signal. The analog signal communicates the primary measured value using the 4 to 20 mA current loop.

Additional information is communicated using a digital signal superimposed on the 4 to 20 mA signal.

Communication occurs between two HART-enabled devices, in this application a Signet 9900 Transmitter and a PLC or handheld device, using standard wiring and termination practices. The HART Protocol communicates at 1200 bits per second without interfering with the 4 to 20 mA signal and allows the PLC or handheld device to communicate two or more updates per second to and from the 9900.

The HART protocol operates according to the master-slave method. Any communication activity is initiated by the master, usually a programmable logic controller (PLC) or a data acquisition system. HART accepts two masters: the primary master - usually the control system (PLC) - and the secondary master - a PC laptop or handheld terminal used in the field.

HART field devices - the slaves - never send without being requested to do so. They respond only when they have received a command message from the master. Once a transaction (i.e., a data exchange between the control station and the field device) is complete, the master will pause for a fixed time period before sending another command, allowing the other master to break in. The two masters observe a fixed time frame when taking turns communicating with the slave devices.

As deployed in the 9900 application, HART allows remote verifying, testing, adjusting and monitoring of primary and secondary device variables. Features available in the 9900 Transmitter with H COMM Module installed:

- **Adjust 4 mA:** Allows fine-tuning to compensate for errors in other equipment connected to the 9900. Adjust the minimum and maximum current output.
- **Adjust 20 mA:** Allows fine-tuning to compensate for errors in other equipment connected to the 9900. Adjust the minimum and maximum current output.
- **Supports Multi-Drop Mode:** Allows up to four 9900 Transmitters be installed in Multidrop mode.
- **Supports all Universal HART Protocol Revision 7.2 commands**
- **Supports many Common Practice Commands**
- **Makes Primary and Secondary values available at PLC.** Secondary values are sensor-dependent and are available with Flow, pH, Conductivity, Resistivity, Salinity and Level sensors.

NOTE:

Level instruments will always send the Level as the Primary and Volume as the secondary

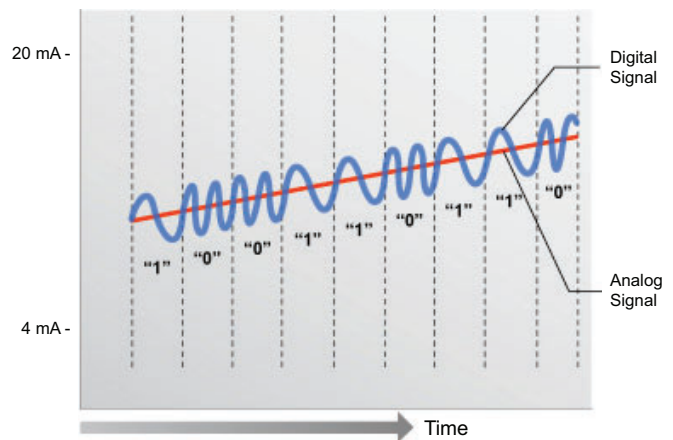

**Frequency Shift Keying
Digital over Analog**

H COMM Module Installation

If the 9900 Base Unit will be mounted in a panel, plug-in modules may be installed either before or after the base unit is mounted. If the 9900 Base Unit will be mounted using the accessory wall mount kit (3-9900.392), install plug-in modules first. If the Direct Conductivity/Resistivity Module will be included in your unit, install the H COMM module first and then install Conductivity/Resistivity Module over the H COMM Module.

To install the H COMM module, carefully align the module pins into its plug (see illustration) and push the module straight in until the tabs on the bottom edge snap into place.

To uninstall, squeeze tabs, grasp the module and pull straight out.

Be careful not to bend the pins when installing or removing the module to or from the base unit.

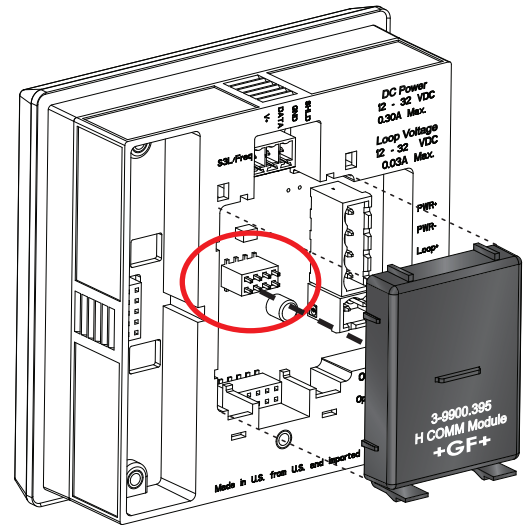

H COMM Module Wiring

Connecting HART with a Loop-powered sensor

Note: Refer to chart on Page 11 for sensors that can be Loop powered.

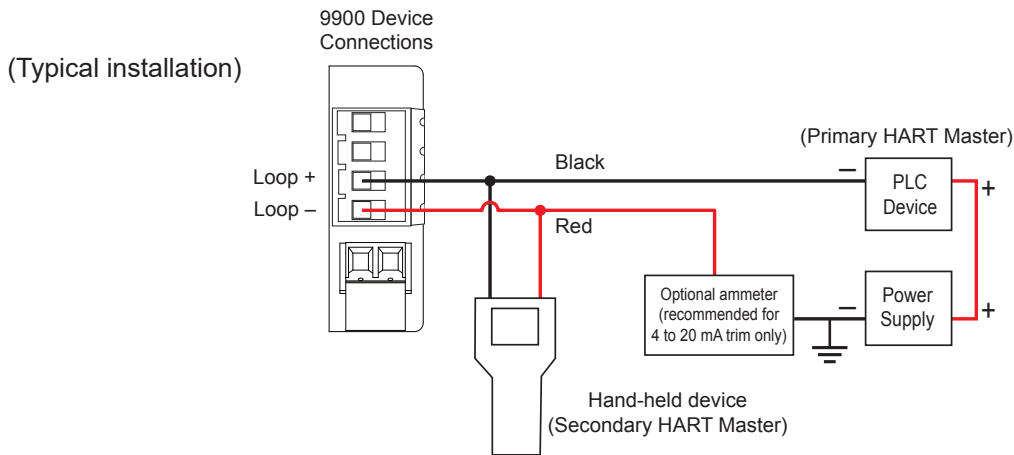

Connecting HART to a Hand-Held Master Device

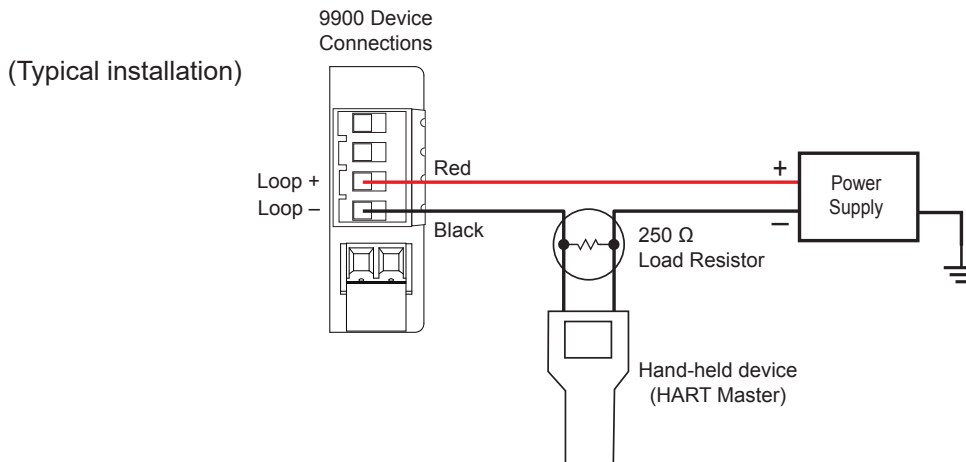

NOTE: On pages 64-69, the term “9900 Transmitter” or “Transmitter” will assume the H COMM Module is installed unless otherwise noted.

Multi-Drop Mode

Up to four 9900 Transmitters can be connected in Multi-Drop mode using the H COMM Module.

To ensure proper operation in Multi-Drop mode, configure each 9900 Transmitter with its own poll address using a configuration tool (laptop or hand-held device).

After configuring the 9900 Transmitter for multi-drop function, reset the Transmitter (remove power for five seconds then apply power) before use.

Connecting HART in Multi-Drop mode

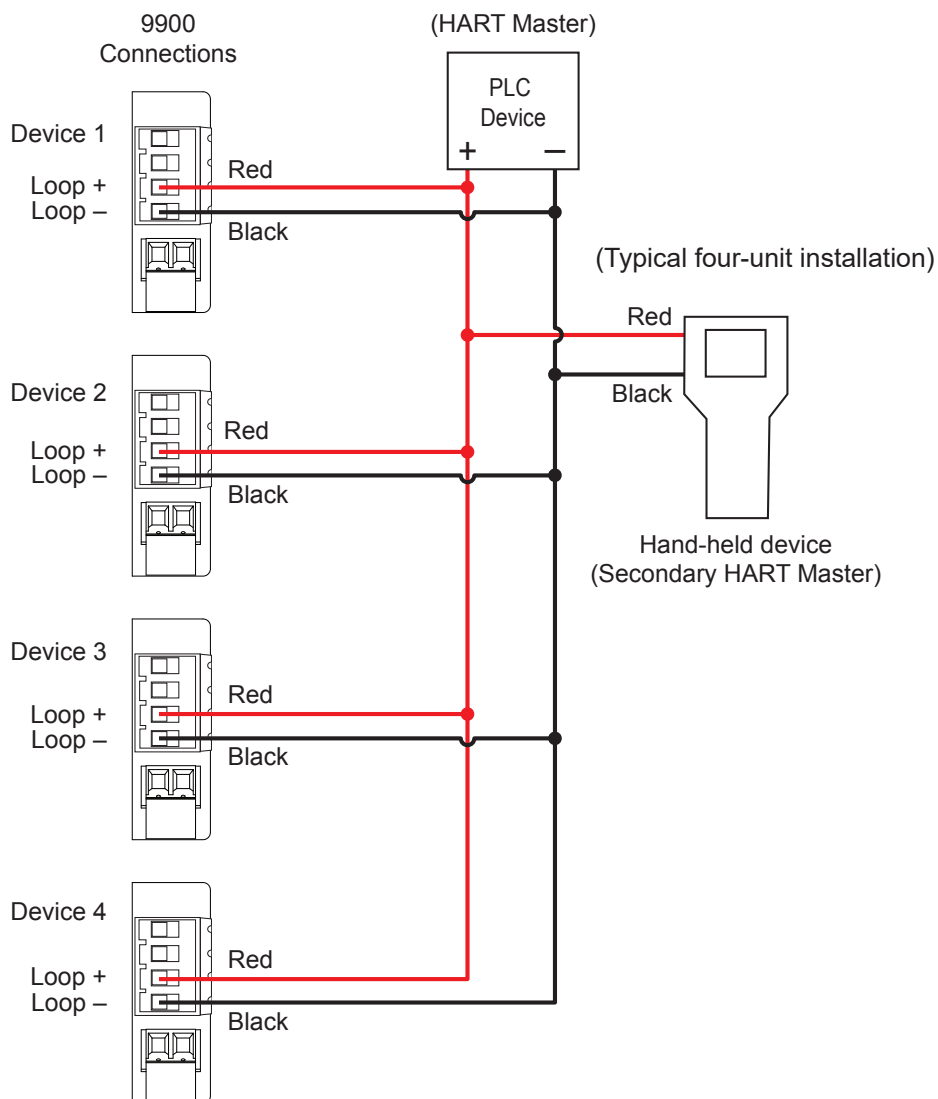

Loop Powered systems require a minimum of 24 VDC. If connecting with DC, nominal 12 VDC is acceptable. (See Power Wiring, pg. 16)

- In LVL/VOL mode, the primary variable will always represent Level, the secondary variable will always represent Volume.
- In pH, Conductivity, Resistivity and Salinity systems the secondary variable represents Temperature.
- In Flow, the secondary variable represents the Totalizer. Select Permanent or Resettable Totalizer in the Input menu (pg. 31).

Loop Current Trim Procedure

The Loop Current HART commands allow a Master HART device to update a loop current value in the 9900 Transmitter and to perform a two-point calibration (zero and span) of the loop current.

1. Use Command 40 (Enter/Exit Fixed Current Mode) to update the 4.00 mA current.
2. Using the measured value of your reference instrument (either a digital multimeter or the HART Master device), set the zero trim using Command 45 (Trim Loop Current Zero). The transmitter will then trim its calibration and return the loop current value in the response message. The response value may differ slightly from the value sent by the Master due to rounding.
3. Use Command 40 (Enter/Exit Fixed Current Mode) to update the 20.00 mA current.
4. Using the measured value of your reference instrument (either a digital multimeter or the HART master device), set the span trim using Command 46 (Trim Loop Current Gain). The transmitter will then trim its calibration and return the loop current value in the response message. The response value may differ slightly from the value sent by the Master due to rounding.
5. Repeat steps 1 through 4 as needed to gain the accuracy desired. Once the loop current is calibrated to your satisfaction, return the device to normal operation by issuing Command 40 (Enter/Exit Fixed Current Mode) with a value of 0.0. This will take the 9900 out of fixed current mode.

Note: With the H COMM Module installed, the following functions are not accessible via the 9900 keypad:

- Trim Loop Current
- Test Loop Current

These functions are only accessible via the HART interface.

Changes to Units of Measure in Transmitter

HART devices can be used to change the units of measure in a 9900 Transmitter. After an update, you must cycle power to the 9900 Transmitter (remove power for 5 seconds, then restore power). In a flow system, the units update automatically and it is not necessary to cycle power to the 9900 Transmitter.

Universal Commands

All HART Rev. 7.2 Universal Commands are supported:

CMD ID	Function
0	Read Unique Identifier
1	Read Primary Variable
2	Read Loop Current And Percent Of Range
3	Read Dynamic Variables And Loop Current
6	Write Polling Address
7	Read Loop Configuration
8	Read Dynamic Variable Classification
9	Read Device Variable With Status
11	Read Unique Identifier Associated With Tag
12	Read Message
13	Read Tag, Descriptor, Date
14	Read Primary Variable Transducer Information
15	Read Device Information
16	Read Final Assembly Number
17	Write Message
18	Write Tag, Descriptor, Date
19	Write Final Assembly Number
20	Read Long Tag
21	Read Unique Identifier Associated With Long Tag
22	Write Long Tag
38	Reset Configuration Changed Flag
48	Read Additional Device Status

Command 0 – Read Unique Identifier

Returns device type, device and software revision levels, device status, and codes for the manufacturer and product information.

Command 1 – Read Primary Variable

Returns the numeric value of the Primary Variable (the 4 to 20 mA current loop) and the unit code for that value (e.g. '45.3' and 'Degrees Celsius').

Command 2 – Read Loop Current and Percent of Range

Returns the loop current value of the 4 to 20 mA current loop and the percent of range (e.g. '12.0' and '50%').

Command 3 – Read Dynamic Variables and Loop Current

Returns the loop current value of the 4 to 20 mA current loop, as well as the numeric value of the Secondary Variable (if present) and the Secondary Value's unit code.

Command 6 – Write Polling Address

Enables (or disables) Multi-Drop mode. While in Multi-Drop mode, loop current is held at a fixed value and is no longer available for signaling. Also sets the polling address of the device for Multi-Drop mode.

Command 7 – Read Loop Configuration

Reads the polling address of the device and the loop configuration (see Command 6).

Command 8 – Read Dynamic Variable Classifications

Returns the classification code for the Primary Variable and Secondary Variable (if present).

Command 9 – Read Device Variable with Status

Returns the value, status, variable code, variable classification and unit code of up to four device variables.

Command 11 – Read Unique Identifier Associated with Tag

Returns all identity information associated with the device, i.e., the device type, device revision level and Device ID. Issued using the 'tag'.

Command 12 – Read Message

Read back the message stored in the device. See Command 17.

Command 13 – Read Tag, Descriptor, Date

Reads the tag, descriptor and date values contained within the device. See Command 18.

Command 14 – Read Primary Variable Transducer Information

Reads transmitter serial number, unit code, upper and lower limits and minimum span for primary variable.

Command 15 – Read Device Information

Returns the alarm selection code, transfer function code, upper and lower range values, write protect code and unit code.

Universal Commands - Continued

Command 16 – Read Final Assembly Number

Returns the assembly number of the device. This will be defined by the customer. See Command 19.

Command 17 – Write Message

Write a message to be stored in the device. See Command 12.

Command 18 – Write Tag, Descriptor, Date

Writes the tag, descriptor and date values into the device. See Command 13.

Command 19 – Write Final Assembly Number

Writes the final assembly number of the device. See Command 16.

Command 20 – Read Long Tag

Read the 32-byte long tag. The 'long tag' is separate from the 'tag' that is used in Commands 13 & 18.

Command 21 – Read Unique Identifier Associated with Long Tag

Returns all identity information associated with the device - the device type, device revision level and Device ID. Issued using the long tag.

Command 22 – Write Long Tag

Write the 32-byte long tag. See Command 20.

Command 38 – Reset Configuration Changed Flag

Resetting the device's configuration changes counter back to 0.

Command 48 – Read Additional Device Status

Returns extended device status information.

Supported HART Common Practice Commands

The following Common Practice Commands are supported.

CMD ID	Function
40	Enter/Exit Fixed Current Mode
45	Trim Loop Current Zero
46	Trim Loop Current Gain
54	Read Device Variable Information

Command 40 - Enter/Exit Fixed Current Mode

The loop current of the 9900 is set to the value transmitted in the command (in milliamperes). Setting a level of '0' exits Fixed Current Mode. If the device is in Multi-Drop mode, Error Code 11 will be returned.

Command 45 – Trim Loop Current Zero

The 9900 will trim its offset of the loop current to match the loop current value sent to it. This is typically performed at 4.00 milliamperes to optimize calibration.

Command 46 – Trim Loop Current Gain

The 9900 will trim the gain of the loop current to match the loop current value sent to it. This is typically performed at 20.00 milliamperes to optimize calibration.

Command 54 – Read Device Variable Information

Returns serial number, limits, damping value and minimum span for a selected device variable.

Unit Codes

The H COMM module uses standard HART Foundation Protocol 7.2 unit codes. The unit code allows the HART Master to interpret and display the units of measure (e.g., GPM, PPB, °F, etc.) with two exceptions.

The following Unit Codes will not be interpreted by the HART Master:

Code	Measurement Unit
240	Cubic Centimeters
244	Parts per Thousand

A HART Master will display these unit codes instead of the units of measure that the code represents.

Specifications

General

Input channelsOne

Enclosure and Display

Case MaterialPBT

WindowShatter-resistant glass

Keypad4 buttons, injection-molded
silicone rubber seal

DisplayBacklit, 7- and 14-segment

Indicators“Dial-type” digital bar graph

Update rate1 s

LCD Contrast5 settings

Enclosure

Size¼ DIN

ColorBlack (Panel Mount),
Yellow and black (Integral Mount)

Mounting

Panel¼ DIN, ribbed on four sides for panel
mounting clip inside panel, silicon
gasket included

FieldMounts to standard Signet field
mount junction boxes. Optional angle
adjustment adapter is available

WallLarge enclosure (sold as an accessory)
that encases the panel mount transmitter

Terminal Blocks

Pluggable screw type: use minimum 105 °C rated wire

Torque ratings

Cond/Res, Open Collector,

Power/Loop0.33 Nm (3.0 lb-in.)

Freq/S³L0.24 Nm (2.2 lb-in.)

Relay0.49 Nm (4.4 lb-in.)

Connector wire gauge:

Power, Loop12 to 28 AWG

Open Collector12 to 28 AWG

Freq/S³L16 to 28 AWG

Module connector wire gauge:

Relay12 to 28 AWG

Cond/Res16 to 28 AWG

Batchup to 14 AWG

4-20 mA Outputup to 14 AWG

Environmental Requirements

Ambient operating temperature:

Backlit LCD-10 °C to 70 °C (14 °F to 158 °F)

Storage Temp-15 °C to 70 °C (5 °F to 158 °F)

Relative Humidity0 to 100% condensing for Field and
Panel Mount (front only);
0 to 95% non-condensing for Panel
Mount back side

Maximum Altitude4,000 m (13,123 ft); use only
DC power supply to maintain
UL safety standard up to this altitude

Enclosure RatingDesigned to meet NEMA 4X/IP65
(front face only on panel mount;
field mount is 100% NEMA 4X/IP65)

Installation Category Cat II

Pollution Degree 2

Shipping Weights

Base Unit0.63 kg (1.38 lb)

H COMM Module0.16 kg (0.35 lb)

Modbus Module0.16 kg (0.35 lb)

Conductivity Module ...0.16 kg (0.35 lb)

Relay Module0.19 kg (0.41 lb)

Batch Module0.16 kg (0.35 lb)

Output Module0.16 kg (0.35 lb)

Performance Specifications

System Accuracy

- Primarily dependent upon the sensor.

System Response

- Primarily dependent upon the sensor. Controller adds a maximum of 150 ms processing delay to the sensor electronics.
- Minimum update period is 100 ms
- System response is tempered by the display rate, output averaging and sensitivity feature.

Electrical Requirements

Power to Sensors

Voltage+4.9 to 5.5 VDC @ 25 °C, regulated

Current1.5 mA max in loop power mode;
20 mA max when using DC power

Short CircuitProtected

IsolationLow voltage (< 48 V AC/DC)
to loop with DC power connected

No isolation when using loop power only

Input Power Requirements

DC (preferred)24 VDC; input range:

10.8 to 35.2 VDC regulated

9900 w/o Relay Module200 mA *

9900 w/ Relay Module300 mA *

*The current draw of the other modules and the sensors are minimal

Loop10.8 to 35.2 VDC

4 to 20 mA (30 mA max.)

Overvoltage protection48 Volt Transient Protection
Device (for DC ONLY)

Current limiting for circuit protection

Reverse-Voltage protection

Loop Characteristics

DC Powered System (preferred)

Max. loop impedance:

@ 12 V loop power250 Ω max.

@ 18 V loop power500 Ω max.

@ 24 V loop power750 Ω max.

Loop Powered System

Max. loop impedance:

@ 12 V loop power50 Ω max.

@ 18 V loop power325 Ω max.

@ 24 V loop power600 Ω max.

Standards and Approvals

- CE, UL, CUL, WEEE
- RoHS Compliant
- Lloyd's Register
- Manufactured under ISO 9001, ISO 14001 and ISO 45001 and OHSAS 18001 for Occupational Health and Safety.

 China RoHS (Go to gfsignet.com for details)

FC Declaration of Conformity according to FCC Part 15

This device complies with Part 15 of the FCC rules.

Operation is subject to the following two conditions:

- (1) This device may not cause harmful interference, and
- (2) This device must accept any interference received, including interference that may cause undesired operation.

Specifications

Relay Specifications

Hysteresis.....	Adjustable (absolute in Engineering Units)
Latch.....	Reset in test screen only
On Delay.....	9999.9 seconds (max)
Cycle Delay.....	99999 seconds (max)
Test Mode.....	Set On or Off
Maximum Pulse Rate.....	300 pulses/minute
Proportional Pulse.....	400 pulses/minute
Volumetric Pulse Width.....	0.1 to 3200 s
PWM period.....	0.1 to 320 s

Open Collector

Type.....	NPN
Max. Voltage Rating.....	30 VDC
Max. Current Rating.....	50 mA

Dry-Contact Relays

Type.....	SPDT
Form.....	C
Max. Voltage Rating.....	30 VDC or 250 VAC
Max. Current Rating.....	5 A resistive

Input Types

- Digital (S³L) or AC frequency
- 4 to 20 mA input via the 8058
- Open collector
- pH/ORP input via the Digital (S³L) output from the 2751 pH/ORP Sensor Electronics
- Raw Conductivity/Resistivity input directly from Signet Conductivity/Resistivity electrodes via Direct Conductivity/Resistivity Module or via the Digital (S³L) output from the 2850 Conductivity/Resistivity Sensor Electronics

Sensor Types:

Flow, pH/ORP, Conductivity/Resistivity, Salinity, Pressure, Temperature, Level/Volume, Dissolved Oxygen, Other (4-20 mA)

Input Specifications

Digital (S ³ L).....	Serial ASCII, TTL level, 9600 bps
Frequency Type Sensors:	
Sensitivity.....	(for coil type sensors): 80 mV @ 5 Hz, gradually increasing with frequency to 2.5 V
Freq. Range.....	(for square wave type sensors): 0.5 Hz to 1500 Hz @ TTL level input or open collector
Accuracy.....	± 0.5% of reading max error @ 25 °C
Range.....	0.5 to 1500 Hz
Resolution.....	1 µs
Repeatability.....	± 0.2% of reading
Power Supply	
Rejection.....	No Effect ± 1 µA per volt
Short Circuit.....	Protected
Reverse Polarity.....	Protected (no isolation when using loop power only)
Update Rate.....	(1/frequency) + 150 ms

Current Outputs

- One 4 to 20 mA output in base unit (additional 4 to 20 mA output available via 3-9900.398-1 Output Module)
- Linear scaling
- Logarithmic scaling for Conductivity
- Reverse span
- Selectable error mode: 3.6 mA or 22 mA
- Test Output mode: allows testing of the current output
- Adjustable 4 to 20 mA end points
- HART communication via optional H COMM Module

Display Ranges:

pH.....	-1.00 to 15.00 pH
pH Temp.....	-99 °C to 350 °C (-146 °F to 662 °F)
ORP.....	-1999 to +1999 mV
Flow Rate.....	-9999 to 99999 units per second, minute, hour or day
Totalizer.....	0.00 to 99999999 units
Conductivity.....	0.0000 to 99999 µS, mS, PPM and PPB (TDS), kΩ, MΩ
Cond. Temp.....	-99 °C to 350 °C (-146 °F to 662 °F)
Temperature.....	-99 °C to 350 °C (-146 °F to 662 °F)
Pressure.....	-40 to 1000 psi
Level.....	-9999 to 99999 m, cm, ft, in, %
Volume.....	0 to 99999 cm ³ , m ³ , in ³ , ft ³ , gal, L, lb, kg, %
Salinity.....	0 to 99.97 PPT
Dissolved O ₂	0 to 20 mg/L, 0 to 200%

Output Specifications

Current Loop Out.....	ANSI-ISA 50.00.01 Class H
Span.....	3.8 to 21 mA
Zero.....	4.0 mA factory set; user programmable from 3.8 to 4.2 mA
Full Scale.....	20.00 mA factory set; user programmable from 19.0 to 21.0 mA
Accuracy.....	± 32 µA max. error @ 25 °C @ 24 VDC
Resolution.....	6 µA or better
Temp. Drift.....	± 1 µA per °C
Pwr Sply Rejection.....	± 1 µA per V
Isolation.....	Low voltage (< 48 VAC/DC)
Voltage.....	10.8 to 35.2 VDC
Max. Impedance:.....	250 Ω @ 12 VDC 500 Ω @ 18 VDC 750 Ω @ 24 VDC
Update Rate.....	100 mS nominal
Actual update rate determined by sensor type	
Short circuit and reverse polarity protected	
Adjustable span, reversible	
Error Condition.....	Selectable error condition 3.6 or 22 mA.
Test Mode.....	Increment to desired current (range 3.8 to 21.00 mA)
Open Collector Output.....	1
Analog Outputs.....	1 passive

Maintenance

- Clean the instrument case and front panel with a soft cotton cloth dampened with a mild liquid soap solution.
- Never wipe the front window with static retentive cloths such as wool or polyester which may induce a static charge. If a static charge develops on the window, you may notice temporary blotches form on the screen. When this occurs, clean the front window with an anti-static cloth, or a soft cotton cloth and anti-static spray or a mild liquid soap solution to remove the static charge.

Ordering Information

9900 Transmitter Base Unit: Single Channel, Multi-Parameter, 4 to 20 mA, Open Collector, DC Power

Mfr. Part No	Code	Description
3-9900-1P	159 001 695	9900 Base Unit, Panel Mount
3-9900-1	159 001 696	9900 Base Unit, Field Mount
Optional Modules		
3-9900.393	159 001 698	Relay Module - 2 DCR (Dry Contact Relays)
3-9900.394	159 001 699	Direct Conductivity/Resistivity Module
3-9900.395	159 001 697	H COMM Module
3-9900.397	159 310 163	Batch Module
3-9900.398-1	159 001 784	4 to 20 mA Output Module
3-9900.270-M2	159 200 121	Modbus Module with Terminal Block Assembly (Panel Mount Only)
3-9900.270-M3	159 200 122	Modbus Module with M12 Connector Assembly (Field Mount Only)
3-9900.270-M4	159 200 128	Modbus Module with Wire Cable Assembly
Accessories		
6682-0204	159 001 709	Conductivity Module Plug, 4 Pos, Right Angle
6682-1102	159 001 710	Open Collector Plug, 2 Pos, Right Angle
6682-1103	159 001 711	Relay Module Plug, 3 Pos, Right Angle
6682-1104	159 001 712	Power/Loop Plug, 4 Pos, Right Angle
6682-3104	159 001 713	Freq/S ³ L Plug, 4 Pos, Right Angle
6682-3004	159 001 725	Freq/S ³ L Plug, In-Line
7310-1024	159 873 004	24 VDC Power Supply, 10 W, 0.42 A
7310-2024	159 873 005	24 VDC Power Supply, 24 W, 1.0 A
7310-4024	159 873 006	24 VDC Power Supply, 40 W, 1.7 A
7310-6024	159 873 007	24 VDC Power Supply, 60 W, 2.5 A
7310-7024	159 873 008	24 VDC Power Supply, 96 W, 4.0 A
3-0252	159 001 808	0252 Configuration Tool
3-8050	159 000 184	Universal Mount Kit
3-8050.396	159 000 617	RC Filter Kit (for relay use), 2 per kit
3-8051	159 000 187	Flow Sensor Integral Mounting Kit, NPT, Valox
3-8051-1	159 001 755	Flow Sensor Integral Mounting Kit, NPT, PP
3-8051-2	159 001 756	Flow Sensor Integral Mounting Kit, NPT, PVDF
3-8052	159 000 188	¾ in. Integral Mount Kit
3-8058-1	159 000 966	i-Go Signal Converter, wire-mount
3-8058-2	159 000 967	i-Go Signal Converter, DIN rail mount
3-9900.390	159 001 714	Standard Connector Kit, Right Angle, (Included with 9900 Transmitter)
3-9900.391	159 001 715	Connector Kit, In-Line, 9900 Transmitter
3-9900.392	159 001 700	Wall Mount Accessory for 9900
3-9000.392-1	159 000 839	Liquid Tight Connector Kit, NPT (1 pc.)
3-9900.396	159 001 701	Angle Adjustment Adapter Kit (for Field Mounting)
3-9900.399-1	159 001 834	Rear enclosure kit, hinged cover
3-9900.399-2	159 001 835	Rear enclosure kit, flat cover
3-9900.270-CB2	159 200 124	Replacement Terminal Block Assembly for M2
3-9900.270-CB3	159 200 125	Replacement M12 Connector Assembly for M3
3-9900.270-CB4	159 200 129	Replacement Cable Assembly for M4
5541-5005	159 855 021	5 Meter (16 feet) M12 Cable
5540-5010	159 855 022	10 Meter (32 feet) M12 Cable



Georg Fischer Signet LLC, 3401 Aero Jet Avenue, El Monte, CA 91731-2882 U.S.A. • Tel. (626) 571-2770 • Fax (626) 573-2057
For Worldwide Sales and Service, visit our website: www.gfsignet.com • or call (in the U.S.): (800) 854-4090
For the most up-to-date information, please refer to our website at www.gfsignet.com